

DT4281 DT4282

HIOKI

Instruction Manual

DIGITAL MULTIMETER



Check for the latest edition and other language versions.



Read carefully before use.
Keep for future reference.

EN

Oct. 2025 Revised edition 12
DT4281A981-12



Contents

Introduction.....	1
Verifying Package Contents	2
Options (sold separately)	2
Safety Notes.....	6
Usage Notes.....	11

1 Overview 15

1.1 Overview and Features	15
1.2 Parts Names and Functions.....	16
1.3 Display	21
1.4 Alarm Display and Battery Indicator	23

2 Preparation for Measurements 25

2.1 Measurement Workflow	25
2.2 Inserting/Replacing Batteries	26
2.3 Using Test Leads.....	28
L9300 Test lead (accessory).....	29
L9207-10 Test lead (option).....	32
2.4 Installation in Measurement Location.....	35
Using the instrument with the stand.....	35
Hanging the instrument with the strap	35

3 Performing Measurements 37

3.1 Inspection Before Use	37
3.2 Measuring Voltage.....	41
Measuring AC voltage.....	41
Measuring DC voltage	42
Measuring synthesized voltage of DC and AC	42
Measuring voltage of DC and AC components.....	43

3.3	Measuring Frequencies	43
3.4	Decibel Conversion (dBm/dBV)	44
3.5	Checking Continuity	45
3.6	Measuring Diode	46
3.7	Measuring Resistance	47
3.8	Measuring Temperatures	48
3.9	Measuring Electrostatic Capacities	50
3.10	Measuring Conductances (DT4282)	51
3.11	Measuring Current	52
	Measuring DC/AC	52
3.12	Measuring AC Using Clamp-on Probe (DT4281)	54
3.13	4-20 mA (0-20 mA) % Conversion	56
3.14	Measuring DC Voltage with the DC High Voltage Probe	57
	Using P2010	58
	Using P2000	59

4 Using Instrument Conveniently 61

4.1	Selecting the Measurement Range	61
	Measuring with the auto range	61
	Measuring with the manual range.....	61
4.2	Retaining the Measured Value	63
	Retaining the measured value manually (HOLD)	63
	Automatically retaining the measured value when the value stabilizes (AUTO HOLD).....	63
4.3	When the Measured Value Fluctuates (SLOW)	65
4.4	Removing the Harmonic Components of the Inverter (FILTER)	66

4.5	Checking the Maximum/Minimum Value (MAX/MIN)	67
4.6	Checking the Peak Value (V • A PEAK)	68
4.7	Checking the Relative Value/Performing Zero Adjustment	69
	Checking the relative value (REL)	69
	Performing zero adjustment.....	70
4.8	Using the Memory Function	71
	Saving the measured value (MEM)	71
	Reading the memory data (READ)	73
	Clearing the memory data (CLEAR)	74
	Clearing all memory data	74
4.9	Muting the Buzzer	75
4.10	Turning On the Backlight	75
4.11	Using the Auto Power Save (APS)	76
4.12	Using Plus/Minus Judgment Function for Measurement Value	77
4.13	Communicating with PC	78
4.14	Setting and Checking the System	80
	Checking that all indicators are displayed	80
	Checking the software version of the instrument	80
	Changing the temperature display unit	81
4.15	Resetting the System	82
	Table of default settings	82
4.16	Power-on Option Table	83

5 Specifications **85**

5.1	Electrical Characteristics	85
5.2	Accuracy Table	87
5.3	General Specifications	101

3

4

5

6

Appx.

6 Maintenance and Service 105

6.1	Repair, Inspection, and Cleaning.....	105
6.2	Troubleshooting	107
6.3	Error Display.....	111
6.4	Replacing Fuses.....	112

Appendix Appx.1

Appx. 1	RMS and Average	Appx.1
Appx. 2	Operation Example	Appx.2
Appx. 3	Dedicated Software (DMM Communicator)	Appx.3

Introduction

Thank you for purchasing the HIOKI DT4281, DT4282 Digital Multimeter. To obtain maximum performance from the product, please read this manual first, and keep it handy for future reference.

Information on download site

For details on the product application, the update file for the instrument, and the instruction manual, please check Hioki's website:

<https://cloud.gennect.net/dl>

An ISO file is a CD or DVD image file. When double-clicked, it will be recognized as a drive and become available for use.



Product registration

Register your product in order to receive important product information.

<https://www.hioki.com/global/support/myhioki/registration/>



Intended audience

This manual has been written for use by individuals who use the product or provide information about how to use the product. In explaining how to use the product, it assumes electrical knowledge (equivalent of the knowledge possessed by a graduate of an electrical program at a technical high school).

Verifying Package Contents

When you receive the instrument, inspect it carefully to ensure that no damage occurred during shipping.

In particular, check the accessories, panel switches, and connectors. If damage is evident, or if it fails to operate according to the specifications, contact your authorized Hioki distributor or reseller.

Check the package contents as follows.

- DT4281 or DT4282**

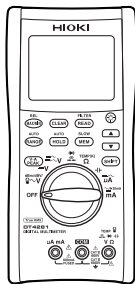

DT4281



DT4282

- L9300 Test Lead (p. 28)**



- LR6 Alkaline battery ×4**



- Instruction Manual**



Please visit Hioki's website to check for versions in other language.

Options (sold separately)

The options listed below are available for the instrument. To order an option, please contact your authorized Hioki distributor or reseller. Options are subject to change. Please check Hioki's website for the latest information.

Connecting cables

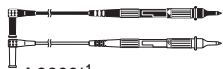

L9300*1

Test Lead (10 A)



L9207-10*1

Test Lead (10 A)

When attaching the L4933 or L4934 to a test lead, do so in the measurement category II configuration (for the L9207-10, with the sleeve removed).

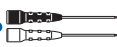

L4933*6

Contact Pin Set (3 A)



L4934*5

Small Alligator Clip Set (3 A)

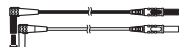

L4930*2

**Connection Cable Set
(10 A) (Length: 1.2 m)**



L4931*2

**Extension Cable Set (10 A)
(Length: 1.5 m, with the
coupling connector)**



P2010*9

DC High Voltage Probe

P2000*9

DC High Voltage Probe



L4935*2

Alligator Clip Set (10 A)



L9243*8

Grabber Clip (1 A)



L4936*4

Bus Bar Clip Set (5 A)



L4937*3

Magnetic Adapter Set (2 A)



L4932*1

Test Pin Set (10 A)

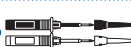

L4938*7

Test Pin Set (10 A)

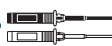

L4939*4

Breaker Pin Set (10 A)

* Figures in parentheses: maximum rated current

*1: CAT IV 600 V/CAT III 1000 V/CAT II 1000 V

*2: CAT IV 600 V/CAT III 1000 V

*3: CAT III 1000 V

*4: CAT III 600 V

*5: CAT III 300 V/CAT II 600 V

*6: 30 V AC/60 V DC

*7: CAT III 600 V/CAT II 600 V

*8: CAT II 1000 V

*9: CAT IV 1000 V/CAT III 2000 V

Options (sold separately)

For the clamp current measurement (only compatible with the DT4281)

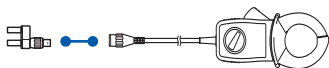

9010-50, 9018-50, 9132-50*4
Clamp-on Probe

9704 Conversion Adapter
CAT III 600 V, CAT II 1000 V

Clamp-on probe	Rated current	Diameter of the measurable conductor
9010-50, 9018-50	500 A rms	ϕ 46 mm or less
9132-50	1000 A rms	ϕ 55 mm or less, 80 × 20 mm bus-bar

Temperature measurement



DT4910 Thermocouples (K) (p. 48)

- Temperature measuring junction: Exposed type (welding)
- Sensor length: Approx. 800 mm
- Operating temperature: -40°C to 260°C (temperature measuring part), -15°C to 55°C (connector)

C0202 Carrying Case



The instrument, test leads, instruction manual, and others can be stored in the case.

Z5020 Magnetic Strap (p. 35)



Attach this strap to the instrument and secure it on the wall surface such as a metal plate for use.

DT4900-01 Communication Package (USB) (p. 78)



- A communication adapter, USB cable, Instruction Manual
- Download from Hioki's website:
USB driver, PC software, and DT4280 series Remote Operation Manual (p. 1)

The instrument data can be stored on the PC.

Z5053 Fuse Set (for DT4282) (p. 112)

Z5054 Fuse Set (for DT4281 and DT4282) (p. 112)

Safety Notes

This instrument is designed to conform to IEC 61010 Safety Standards, and has been thoroughly tested for safety prior to shipment. However, using the instrument in a way not described in this manual may negate the provided safety features.

Before using the instrument, be certain to carefully read the following safety notes.

DANGER



Mishandling during use could result in injury or death, as well as damage to the instrument. Be certain that you understand the instructions and precautions in the manual before use.

WARNING



With regard to the electricity supply, there are risks of electric shock, heat generation, fire, and arc discharge due to short circuits. If persons unfamiliar with electricity measuring instruments are to use the instrument, another person familiar with such instruments must supervise operations.

Protective gear







WARNING











To avoid electric shock when measuring live lines, wear appropriate protective gear, such as insulated rubber gloves, boots and a safety helmet.

Notation



In this manual, the risk seriousness and the hazard levels are classified as follows.

 DANGER	Indicates an imminently hazardous situation that will result in death or serious injury to the operator.
 WARNING	Indicates a potentially hazardous situation that may result in death or serious injury to the operator.
 CAUTION	Indicates a potentially hazardous situation that may result in minor or moderate injury to the operator or damage to the instrument or malfunction.
IMPORTANT	Indicates information related to the operation of the instrument or maintenance tasks with which the operators must be fully familiar.
	Indicates a high voltage hazard. If a particular safety check is not performed or the instrument is mishandled, this may give rise to a hazardous situation; the operator may receive an electric shock, may get burnt or may even be fatally injured.
	Indicates a strong magnetic-field hazard. The effects of the magnetic force can cause abnormal operation of heart pacemakers and/or medical electronics.
	Indicates prohibited actions.
	Indicates the action which must be performed.
*	Additional information is presented below.

Symbols affixed to the instrument

	Indicates cautions and hazards. When the symbol is printed on the instrument, refer to a corresponding topic in the Instruction Manual.
	Indicates that dangerous voltage may be present at this terminal.
	Indicates a double-insulated device.
	Indicates a fuse.
	Indicates a grounding terminal.
	Indicates DC (Direct Current).
	Indicates AC (Alternating Current).
	Indicates DC (Direct Current) or AC (Alternating Current).

Symbols for various standards

	Indicates that the product is subject to the Waste Electrical and Electronic Equipment (WEEE) Directive in EU member nations. Dispose of the product in accordance with local regulations.
	Indicates that the product complies with standards imposed by EU directives.

Screen display

This instrument uses the following screen displays.

A	B	C	D	E	F	G	H	I	J	K	L	M	N	O	P	Q	R	S	T	U	V	W	X	Y	Z
A	b	C	d	E	F	G	H																		

1	2	3	4	5	6	7	8	9	0
1	2	3	4	5	6	7	8	9	0

A different display is used in the case below.

OPEN

Appears when a broken Thermocouple (K) is detected. (p. 48)

Accuracy

We define measurement tolerances in terms of rdg. (reading) and dgt. (digit) values, with the following meanings:

rdg.	(Reading or displayed value) The value currently being measured and indicated on the measuring instrument.
dgt.	(Resolution) The smallest displayable unit on a digital measuring instrument, i.e., the input value that causes the digital display to show a "1" as the least significant digit.

Measurement categories

To ensure safe operation of measuring instruments, IEC 61010 establishes safety standards for various electrical environments, categorized as CAT II to CAT IV, and called measurement categories.

DANGER



- **Using a measuring instrument in an environment designated with a higher-numbered category than that for which the instrument is rated could result in a severe accident, and must be carefully avoided.**
- **Using a measuring instrument without categories in an environment designated with the CAT II to CAT IV category could result in a severe accident, and must be carefully avoided.**

This instrument conforms to the safety requirements for CAT III 1000 V, CAT IV 600 V measuring instruments.

CAT II: When directly measuring the electrical outlet receptacles of the primary electrical circuits in equipment connected to an AC electrical outlet by a power cord (portable tools, household appliances, etc.)

CAT III: When measuring the primary electrical circuits of heavy equipment (fixed installations) connected directly to the distribution panel, and feeders from the distribution panel to outlets

CAT IV: When measuring the circuit from the service drop to the service entrance, and to the power meter and primary overcurrent protection device (distribution panel)

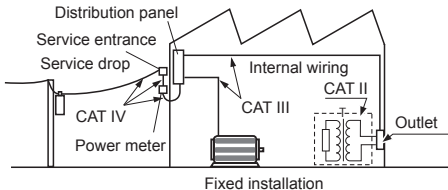

See: "2.3 Using Test Leads" (p. 28)

Usage Notes

Follow these precautions to ensure safe operation and to obtain the full benefits of the various functions.

Use of the instrument should confirm not only to its specifications, but also to the specifications of all accessories, options, batteries, and other equipment in use.

DANGER

If the test lead or the instrument is damaged, there is a risk of electric shock. Before using the instrument, perform the following inspection.



- Before using the instrument, check that the coating of the test leads are neither ripped nor torn and that no metal parts are exposed. Using the instrument under such conditions could result in electrocution. Replace the test leads with those specified by our company.
- Before using the instrument for the first time, verify that it operates normally to ensure that no damage occurred during storage or shipping. If you find any damage, contact your authorized Hioki distributor or reseller.

Installation

Installing the instrument in inappropriate locations may cause a malfunction of instrument or may give rise to an accident. Avoid the following locations. For details on the operating temperature and humidity, see the specifications. (p. 101)

CAUTION



- Exposed to direct sunlight or high temperature
- Exposed to corrosive or combustible gases
- Exposed to water, oil, chemicals, or solvents
- Exposed to high humidity or condensation
- Exposed to a strong electromagnetic field or electrostatic charge
- Exposed to high quantities of dust particles
- Near induction heating systems (such as high-frequency induction heating systems and IH cooking equipment)
- Susceptible to vibration

Handling the cables

WARNING

To prevent electric shock, when measuring the voltage of a power line use a test lead that satisfies the following criteria:



- Conforms to safety standards IEC 61010 or EN 61010
- Of measurement category III or IV
- Its rated voltage is higher than the voltage to be measured

All of the optional test leads for this device conform to the safety standard EN 61010. Use a test lead in accordance with its defined measurement category and rated voltage.

CAUTION



- Avoid stepping on or pinching the cable, which could damage the cable insulation.
- To avoid damaging the cables, do not bend or pull the leads and the probe bases.



The ends of the test leads are sharp. Be careful to avoid injury.

For the test leads supplied with the instrument or the options to be connected to the instrument, see the following information.

Accessories and options	Reference
Test lead	"2.3 Using Test Leads" (p. 28)
Thermocouples (K)	"3.8 Measuring Temperatures" (p. 48)
Clamp-on probe	See the Instruction Manual which accompanies the optional clamp.
USB cable	"4.13 Communicating with PC" (p. 78)
Magnetic strap	"2.4 Installation in Measurement Location" (p. 35)

Precautions during measurement

WARNING



If the instrument is used in locations where the rating indicated on the instrument or probes is exceeded, the instrument may be damaged resulting in personal injury. Do not use the instrument in such locations. See “Measurement categories” (p. 10).

- With regard to the 10 A range, the maximum input current is 10 A DC/10 A rms AC. Supplying a current in excess of the maximum input may damage the instrument and result in personal injury. Do not supply current in excess of the specified limit. (Only the DT4282)

Observe the following to avoid electric shock and/or short circuits.



- Hazardous voltage may be generated in a free measurement terminal. Do not touch the free terminal.
- Use only test leads and optional equipment specified by our company.
- Do not allow the metal part of the test lead to touch any exposed metal, or to short between 2 lines. Never touch the metal end.
- When connecting the clip-type test lead to the active terminal, do not allow the lead to touch any exposed metal, or to short between 2 lines.
- When the clamp-on probe is opened, do not allow the metal part of the clamp to touch any exposed metal, or to short between 2 lines, and do not use over bare conductors. (For the clamp current measurement, only the DT4281)

CAUTION



- Do not input voltage or supply current exceeding the specified measurement range. Doing so may damage the instrument.
- During the continuity check, diode test, or measurement of resistance, conductance, or electrostatic capacity, measurement signals are generated in the terminals of the instrument. Depending on the target for measurement, the measurement signal may cause damage. Seeing “Measurement current” and “Open circuit voltage” in the accuracy table (p. 87), check, in advance, that there are no adverse effects of the measurement current and the open circuit voltage.

Precautions during shipment

Observe the following during shipment. Hioki cannot be responsible for damage that occurs during shipment.

CAUTION



- During shipment of the instrument, handle it carefully so that it is not damaged due to a vibration or shock.
- To avoid damage to the instrument, remove the accessories and optional equipment from the instrument before shipment.

If the instrument is not to be used for an extended period of time

IMPORTANT

To avoid corrosion and/or damage to the instrument due to battery leakage, remove the batteries from the instrument if it is to be kept in storage for an extended period.

1.1 Overview and Features

This measuring instrument is a multi-function, high-precision digital multimeter which ensures both safety and durability.

Main features

- Speedy display of the RMS measured value
- Environmental performance (can be used anywhere) (Operation temperature: -15 to 55°C)
- High noise-proof performance
- Filter function effective for the inverter measurement
- Solid body which can be used for an extended period of time (drop-proof)
- High accuracy (DCV: 0.025%), wide band (20 Hz to 100 kHz) measurement
- Speedy measurement via a fast response (0 V → 100 V response 1 second*)

* Until the value falls within the accuracy specification range.

Useful functions during measurement

- Noise reduction (FILTER)
- Display stability (SLOW)
- Display hold (HOLD)
- Maximum/Minimum value display

If too many data are entered, a hazard is indicated by the red backlight.

Large, easily-viewable display
Backlighting for use in dark environments

Problem finding a suitable installation location?

The strap with magnet allows the device to be hung conveniently.

**For the DC power supply maintenance**

The peak measurement function is used to capture the ripple voltage superimposed on the DC signal.

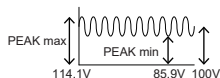
**Memorizing measured values**

For control of the UPS battery cell voltage, etc., the measurement value can be saved to the embedded memory (up to 400 data). The measurement value can also be read.

Data transmission to PC, control

The optional DT4900-01 Communication Package is required.



The measurement test leads and the end pins can be selected depending on the purpose of use.

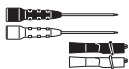

1.2 Parts Names and Functions

Front

Some indications are different between the DT4281 and DT4282.

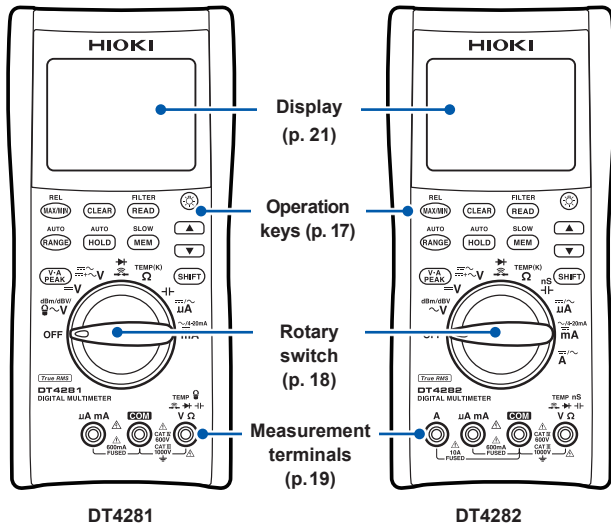

Operation keys

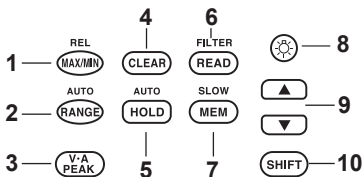

(*) Pressing a key **for at least 1 second** activates the function indicated above the key. To disable the function, change the rotary switch setting.

1

- | | | |
|----|--|---|
| 1 | | <ul style="list-style-type: none"> • Displays the maximum or minimum value. (p. 67) • (*) activates the relative value display function. (p. 69) |
| 2 | | <ul style="list-style-type: none"> • Selects the range (manual range). (p. 61) • (*) changes to the auto range. (The default is the auto range.) |
| 3 | | Changes to the peak measurement. The maximum or minimum instantaneous value is measured. (p. 68) |
| 4 | | <ul style="list-style-type: none"> • Deletes the stored data. (p. 74) • Clears the maximum or minimum value. (p. 67) • Clears the peak value. (p. 68) |
| 5 | | <ul style="list-style-type: none"> • Retains the displayed value. (p. 63) • (*) activates the auto hold function. |
| 6 | | <ul style="list-style-type: none"> • Reads the stored data. (p. 73) • (*) toggles the filter function between on and off. (p. 66) |
| 7 | | <ul style="list-style-type: none"> • Saves the measurement data. (p. 71) • (*) toggles the display update speed between normal and slow. ([SLOW] is used to stabilize the display.) (p. 65) |
| 8 | | Turns on or off the display backlighting. (p. 75) |
| 9 | | Increases/Decreases the memory No. or numeric value. (When ▲/▼ are displayed on the LCD, these keys can be operated.) |
| 10 | | Changes the function of the rotary switch to that indicated shown in blue. |

Rotary switches and measurement descriptions

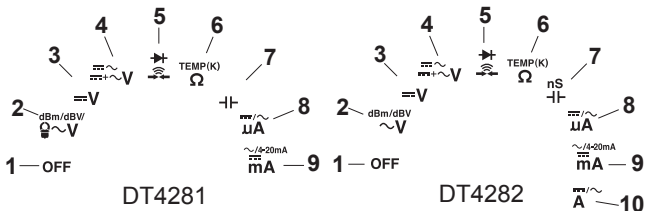
**SHIFT**

is used to change to the measurement shown in blue.

DT4281: DT4281 only, DT4282: DT4282 only)

1	OFF	Turns off the power to the instrument.
2	dBm/dBV 	AC voltage measurement (p. 41) → dBm measurement → dBV measurement (p. 44) → DT4281 Clamp current measurement (p. 54)
3	=V	DC voltage measurement (p. 42)
4		Synthesized voltage measurement of DC and AC → Voltage measurement of AC and DC components (p. 42)
5		Continuity check (p. 45) → Diode test (p. 46)
6	TEMP(K) Ω	Resistance measurement (p. 47) → Temperature measurement (compatible with the Thermocouples (K)) (p. 48)
7	nS F	Capacitance measurement (p. 50) → DT4282 Conductance measurement (p. 51)
8	μA	(6000 μA range) DC measurement → AC measurement (p. 52)
9	mA	(600 mA range) DC measurement → AC measurement (p. 52) → % conversion of the 4-20 mA input (The % conversion of the 0-20 mA input can be specified via the power-on option.) (p. 56)
10	A	DT4282 (10 A range) DC measurement → AC measurement (p. 52)

Measurement terminals

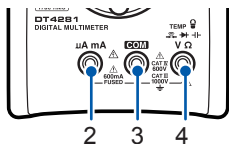

DT4281

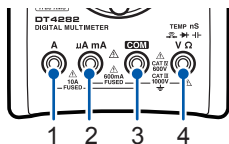

DT4282

- 1 **DT4282**
Current measurement (A) terminal. The red test lead is connected. When the rotary switch is set to the current measurement, the shutter opens.
- 2 Current measurement (μA , mA) terminal. The red test lead is connected. When the rotary switch is set to the current measurement, the shutter opens.
- 3 Commonly used for each measurement. The black test lead is connected.
- 4 Used for voltage measurement, resistance measurement, continuity check, diode test, temperature measurement, clamp current measurement **DT4281**, or conductance **DT4282**. Hereafter referred to as “V terminal”.
The red test lead is connected.
When the rotary switch is set to any of the measurements above, the shutter of the current measurement terminal is closed.

Be sure to carefully read the precautions in the following references.

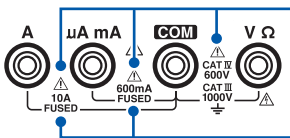

See “Precautions during measurement” (p. 13).

See “Replacing Fuses” (p. 112).

Rear

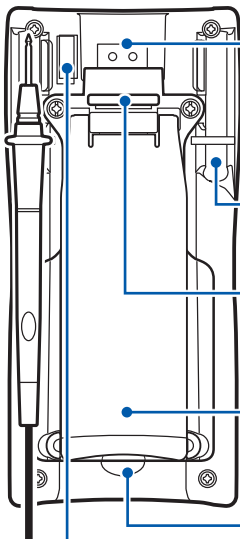

Communication port

When the communication adapter supplied with the optional DT4900-01 Communication Package is connected, the data can be transmitted to the PC. (p. 78)

Test lead holder

The test lead can be held.

Strap hole

The optional Z5020 Magnetic Strap can be attached. (p. 35)

Stand

The instrument can be set on the stand. (p. 35)

Battery cover

When replacing the batteries (p. 26) or fuse (p. 112), remove the cover.

 See p. 26.

Serial number







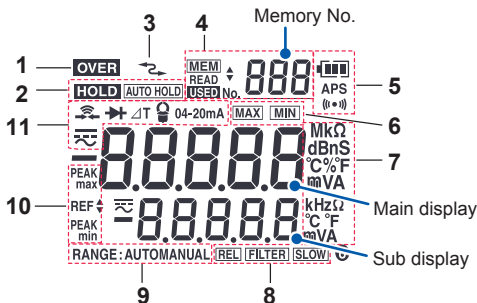











For the latest information, check Hioki's website.
Do not remove this sticker because the number is required for product tracking.

1.3 Display

For error displays, see “6.3 Error Display” (p. 111).



1	OVER	Blinks if the maximum value in each range is exceeded. (Voltage, current, continuity, diode, resistance, temperature, electrostatic capacity, conductance)
2	HOLD	Holds measured value. (p. 63)
	AUTO HOLD	The auto hold function is activated. (p. 63)
3		Communicating with the PC. (p. 78)
	MEM	The memory function is activated. (p. 71)
4	READ	Memory reading state (p. 73)
	USED	Stored data exist. (p. 71)
		can be operated. (p. 71)
		Battery indicator (p.24)
5	APS	The auto power save function is activated. (p. 76)
		The buzzer can be used. (p. 75)

6		Maximum value (p. 67)
		Minimum value (p. 67)
7	(Unit)	Each unit
8		The display update (sampling) is performed at SLOW speed. (p. 65)
		The filter function is activated. (p. 66)
		The relative value display function is activated. (p. 69)
9	RANGE: AUTO	Auto range (p. 61)
	MANUAL	Manual range (p. 61)
10		Maximum value in the peak measurement (p. 68)
		Minimum value in the peak measurement (p. 68)
	REF 	When   are displayed,  /  can be used to change values. Threshold of the continuity check (p. 45) Threshold of the diode test (p. 46)
11		AC measurement
		DC measurement
		AC measurement + DC measurement
	ΔT	During the temperature measurement, the temperature difference from the standard is displayed. (p. 48)
		Continuity check (p. 45)
		Diode test (p. 46)
		 Clamp current measurement (p. 54)
04-20mA	% conversion measurement of 4-20 mA (0-20 mA) (p. 56)	

( : DT4281 only,  : DT4282 only)

1.4 Alarm Display and Battery Indicator

The following conditions are informed via the red backlight, **OVER** display, and buzzer.

When the maximum input range is exceeded

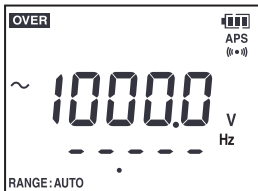

Voltage/Current measurement

OVER blinks, the red backlight blinks, the maximum value within the maximum range blinks, and the buzzer sounds.

Corrective action:

Immediately move the test leads away from the measurement object.

When the measured value exceeds the maximum value in each range (Range over)

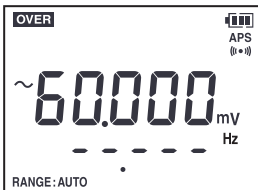

Voltage/Current measurement

OVER blinks, the red backlight lights up, and the maximum value blinks.

Corrective action:

RANGE Change the range.

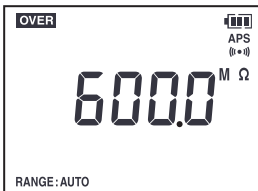

Measurements other than voltage and current

OVER and the maximum value blinks.

Corrective action:

Change the range, or measure the samples in the specified range. If the same symptom still occurs, check that the test leads are not broken. (p.38)





When the Thermocouple (K) is broken (Temperature measurement)



Corrective action:

Check that the thermocouple has been connected correctly to the measurement terminal. If the display does not change, replace with a new Thermocouple (K). (p. 48)

Battery indicator

	Fully charged.	(Charge: 60% or more)
	As the battery charge diminishes, black charge bars disappear, one by one, from the left of the battery indicator.	(Charge: 20% or more)
	The battery voltage is low. Replace the batteries as soon as possible.	(Charge: 5% or more)
	(Blinks) The battery is exhausted. Replace the batteries.	(Charge: less than 5%)

The charge is only a reference for the continuous operation time. (p. 102)

Power shutdown



When the charge is 0% (less than $3.8\text{ V} \pm 0.2\text{ V}$), [bAtt Lo] is displayed for 1 second and the power is shut down.

2

Preparation for Measurements

2.1 Measurement Workflow

Before using the instrument, be sure to read “Usage Notes” (p. 11).

Installation and connection

Insert the batteries. (p. 26)

As necessary, have other optional items available and ready.

Perform the startup check. (p.37)

Measurement

Turn on the power and select the measurement function.

Attach the test leads to the measurement terminals. (p. 28)
(As necessary, perform zero adjustment. (p. 70))

Connect the test leads to the measurement object.

(As necessary)

Hold the display of the measured value. (p. 63)
Save the measured value. (p. 71)

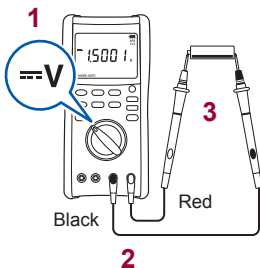

End of the measurement

Move the test leads away from the measurement object and then turn off the power.

2.2 Inserting/Replacing Batteries

Before using the instrument first time, insert four LR6 Alkaline batteries. Before measurements, check that the battery level is sufficient. When the battery charge diminishes, replace the batteries.

WARNING



To avoid electric shock, disconnect the test leads from the object to be measured before replacing the batteries.



To avoid the possibility of explosion, do not short circuit, charge, disassemble, or incinerate batteries.



After battery replacement but before using the instrument, reattach and screw down the battery cover.

CAUTION

Poor performance or damage from battery leakage could result. Observe the cautions listed below.



- Do not mix new and old batteries, or different types of batteries.
- Be careful to observe the battery polarity during installation.
- Do not use batteries after their recommended expiry date.
- Do not allow used batteries to remain in the instrument.



- To avoid corrosion from battery leakage and/or damage to the instrument, remove the batteries from the instrument if it is to be kept in storage for an extended period.

- The  indicator appears when the battery charge diminishes. Replace the batteries as soon as possible.
- After use, be sure to turn off the instrument.
- Handle and dispose of batteries in accordance with local regulations.

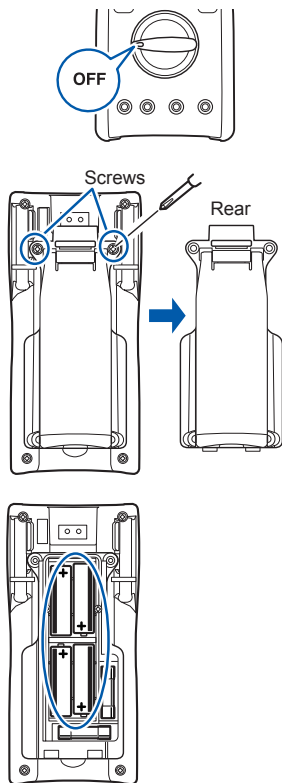

- 1** Have the following items available and ready.
 - Phillips screwdriver
 - LR6 Alkaline battery or R6 Manganese battery × 4
- 2** Remove the test leads from the instrument.
- 3** Set the rotary switch to OFF.
- 4** Using a Phillips screwdriver, remove the screws (2 locations) from the battery cover on the rear of the instrument.
- 5** Remove the battery cover.
- 6** When replacing the batteries, remove all old batteries.
- 7** Insert 4 new batteries (LR6 or R6), being careful to the battery polarity.
- 8** Reattach the battery cover.
- 9** Secure the cover with the screws.

After the battery cover is removed, the fuse can be seen. When replacing the fuse, see “6.4 Replacing Fuses” (p. 112).

2.3 Using Test Leads

The L9300 Test Lead (accessory) or the L9207-10 Test Lead (option) is used for measurement.

Depending on measurement locations, use our optional measurement cables. For details on the optional items, see “Options (sold separately)” (p. 2).

WARNING

When using the instrument, use the test leads and options specified by Hioki.



Using test leads and options other than those specified could cause bodily injury or short circuit accidents.

When measuring the power line voltage, use test leads that satisfy the following conditions.

- IEC 61010 or EN 61010 safety standard-compliant
- Rated for measurement category III or IV
- Rated voltage higher than voltage being measured



Failure to do so may cause electric shock.

The optional test leads for this instrument comply with the EN 61010 safety standard. Observe the measurement category and rated voltage indicated on the test leads during use.

CAUTION

- Do not step on cords or allow them to be caught between other objects. Doing so may damage insulation, resulting in electric shock.
- Do not touch the tips of test leads. The tips of test leads are sharp and could injure the user.
- Do not bend or pull on cables at temperatures of 0°C or lower. Since cables become rigid, doing so could damage the insulation or cause a wire break, resulting in electric shock.



L9300 Test lead (accessory)

See the precautions in “2.3 Using Test Leads” (p. 28) as well.

⚠ WARNING



- Use the test leads with the correct measurement category displayed.
- Do not use the test leads if the metal pin is bent or the protective finger guard does not slide properly. Doing so could cause short circuit accidents.

2

Appearance of the L9300

For measurement in category III, IV

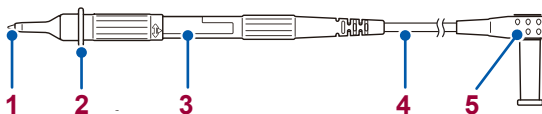

For measurement in category II

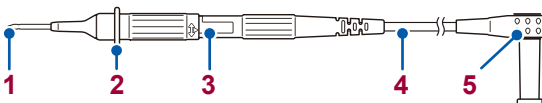

See: “Measurement categories” (p. 10)

1	Metal pin	Connected to the object to be measured For measurement in category III, IV: 4 mm or less For measurement in category II: 19 mm or less Diameter: Approx. 2 mm
2	Protective finger guard	Protects the user from hazardous voltage. Do not touch the area toward the end from the protective finger guard during measurement.

3	Measurement category display	The measurement category display changes when the protective finger guard is slid. Use the test leads with the correct measurement category displayed.
4	Cable	Double sheathed cables (Length: approx. 955 mm, diameter: approx. 3.6 mm) <div data-bbox="329 346 927 426" style="border: 2px solid blue; padding: 5px; margin-top: 10px;">When the white portion inside the cable is exposed, replace the test lead with a new L9300.</div>
5	Plug	Connected to the measurement terminals on this instrument. (p. 19) Protective sleeves are provided. Remove them before use.

Changing the measurement category

1 Unlock the protective finger guard.

Unlock by rotating to align the ▷ mark with the guide line.

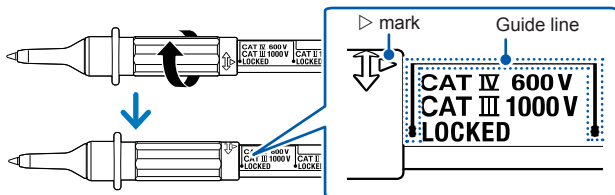

2

2 Slide the protective finger guard.

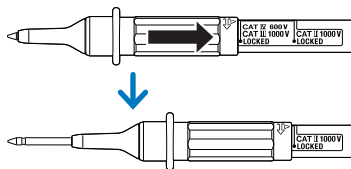

Slide the ▷ mark along the guide line.

3 Lock the protective finger guard.

Lock by rotating to align the ▷ mark with the guide line.

Rotate it until you hear a sound and make sure that the ▷ mark is pointing at **[LOCKED]**.

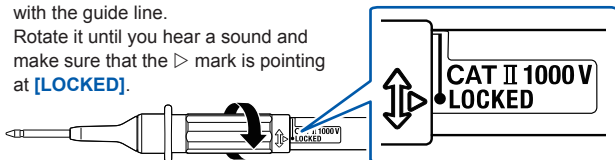

Perform the above steps to change from measurement category II to measurement category III or IV as well.

L9207-10 Test lead (option)

See the precautions in “2.3 Using Test Leads” (p. 28) as well.

WARNING



- To prevent a short circuit accident, be sure to use the test leads with the sleeves attached when performing measurements in the CAT III and CAT IV measurement categories. (For the measurement categories, see “Measurement categories” (p. 10).)
- If the sleeves are inadvertently removed during measurement, stop the measurement.

CAUTION



When using the test leads with the sleeves attached, verify that the sleeves are free of damage. Performing measurement with a damaged sleeve attached could cause the user to experience electric shock.

Appearance of the L9207-10

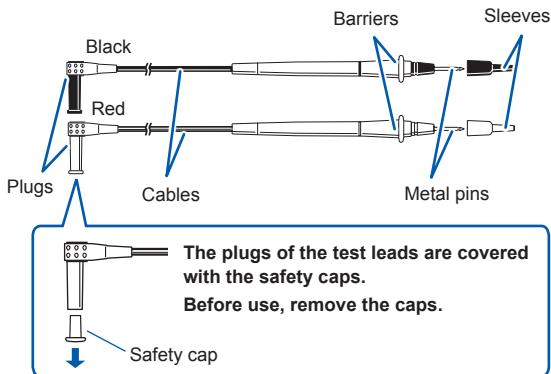

Metal pin	Connect to the object to be measured. 4 mm or less (sleeve attached) 19 mm or less (sleeve removed) Diameter ϕ approx. 2 mm
Sleeve	Attach to the metal pins to prevent short circuit accidents.
Barrier	Represents the safe handling distance from the metal pins.
	During measurement, do not touch the area between the barrier and the tip of the sleeve.
Plug	Connect to the measurement terminals on this instrument.
Cable	Double sheathed cables (Length: approx. 900 mm, Diameter: ϕ approx. 3.6 mm)
	When the white portion inside the cable is exposed, replace with a new L9207-10 Test Lead.

Removing and attaching the sleeves

Removing the sleeves

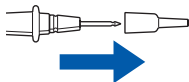

Hold the bottom of the sleeves and pull the sleeves off. Safely store the removed sleeves so as not to lose them.

Attaching the sleeves

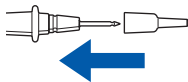

Insert the metal pins of the test leads into the holes of the sleeves, and firmly push them all the way in.

Connecting to the instrument

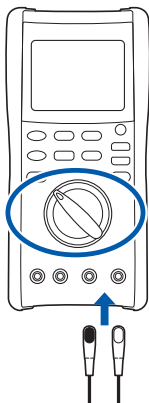

- 1 Turn the rotary switch to the desired measurement function.
- 2 Connect the test leads to the relevant measurement terminals.

- Besides the current measurement (excluding the clamp)

COM terminal Connect the black test lead.
V terminal Connect the red test lead.

- Current measurement

COM terminal Connect the black test lead.
 $\mu\text{A}/\text{mA}$ terminal Connect the red test lead.
A terminal (Only the DT4282)

2.4 Installation in Measurement Location

Using the instrument with the stand

Position the instrument with the stand at the rear.

CAUTION



- Do not position the instrument on an unstable table or inclined surface.
- When the instrument is set on the stand, do not apply a strong force above. Doing so may damage the stand.

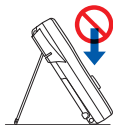

Hanging the instrument with the strap

Attach the optional Z5020 Magnetic Strap to the instrument and attach the magnet to the wall surface (with metal plate affixed).

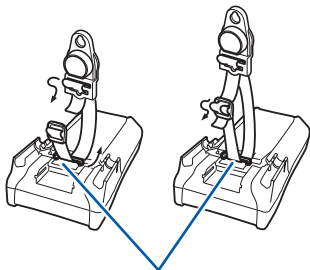

Strap holes

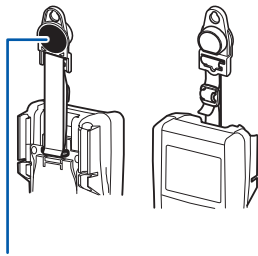

Magnet

Attach it to the wall surface (with metal plate affixed).

DANGER



Those with medical electronics such as pacemakers should not use the Z5020 Magnetic Strap. Nor should such persons approach the Z5020. It is extremely dangerous. The electronics may not operate properly and the life of the operator may be put at great risk.

CAUTION



- Do not use the Z5020 in locations where it may be exposed to rainwater, dust, or condensation. In those conditions, the Z5020 may be decomposed or deteriorated. The magnet adhesion may be diminished. In such case, the instrument may not be hung in place and may fall.
- Do not bring the Z5020 near magnetic media such as floppy disks, magnetic cards, pre-paid cards, or magnetized tickets. Doing so may corrupt and may render them unusable. Furthermore, if the Z5020 is brought near precision electronic equipment such as PCs, TV screens, or electronic wrist watches, they may fail.

3.1 Inspection Before Use

Before using the instrument the first time, verify that it operates normally to ensure that no damage occurred during storage or shipping. If you find any damage, contact your authorized Hioki distributor or reseller.

Appearance check of the instrument and test leads

Check item	Action
The instrument is neither damaged nor cracked. The internal circuits are not exposed.	Visually check the instrument. If it is damaged, there is a risk of electric shock. Do not use the instrument but send it for repair.
The terminals are not contaminated with debris.	Remove contamination with a cotton swab.
The coating of the test leads is neither broken nor frayed, or the white portion or metal part within the lead is exposed.	If the test lead is damaged, there is a risk of electric shock. Do not use the instrument but send it for repair.

Check when turning on the power

(Set the rotary switch to any position other than OFF.)

Check item	Action
The battery voltage is sufficient.	When the  indicator appears in the top right corner of the display, the battery voltage is low. Replace the batteries as soon as possible.

Check item	Action
No indicators are missing.	Display all indicators and ensure that no indicators are missing. (p. 80) If any of the indicators are missing, send the instrument for repair.

Operation check

This section introduces some of the operation checks. Periodical calibration is necessary in order to ensure that this instrument operates according to its specifications.

1 Check that the test leads are not broken.

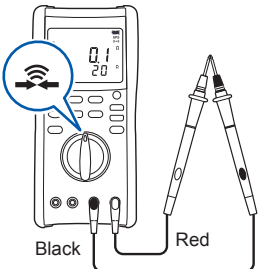
Check method	Action
<p>Regarding the continuity check, deliberately short circuit the test leads and then check the display.</p> 	<p>Normal: The value stabilizes at around 0.1 Ω to 0.2 Ω.</p> <p>Abnormal: A numeric value other than the above appears.</p> <p>Corrective action: The test leads may be broken. Replace with those specified by our company. If the same phenomena persist even after the test leads are replaced, a malfunction may occur. Halt inspection and then send the instrument for repair.</p>

2 Measure samples (such as battery, commercial power supply, and resistor) of which values have already been known, and check that the appropriate values appear.

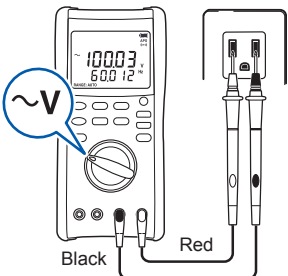
Check method	Action
<p>Example: Perform the AC voltage measurement to measure the commercial power supply, and then check the display.</p> 	<p>Normal: An already-known value appears. (In this example, the commercial voltage level should appear.)</p> <p>Abnormal: The measured value does not appear. The malfunction may occur. Stop the inspection and do not use the instrument.</p>

3

3 Check that the fuse is not broken.

Check method	Action							
<ol style="list-style-type: none"> Remove the fuse from the instrument. (p. 112) Reattach the battery cover. In the resistance measurement, check the resistance of the fuse. (Resistance measurement (p. 47)) 	<p>Normal:</p> <table border="1" data-bbox="526 1059 919 1199"> <thead> <tr> <th>Fuse rating</th> <th>Resistance</th> </tr> </thead> <tbody> <tr> <td>630 mA</td> <td>Approx. 1.2 Ω</td> </tr> <tr> <td>11 A</td> <td>0.1 Ω or less</td> </tr> </tbody> </table> <p>Abnormal: If the value above is not obtained (the value higher than that is displayed), replace the fuse. (p. 112)</p>		Fuse rating	Resistance	630 mA	Approx. 1.2 Ω	11 A	0.1 Ω or less
Fuse rating	Resistance							
630 mA	Approx. 1.2 Ω							
11 A	0.1 Ω or less							

Before measurements

WARNING

Observe the following to avoid short circuit accidents.



- Always verify the appropriate setting of the rotary switch before connecting the test leads.
- Disconnect the test leads from the measurement object before switching the rotary switch.
- Operate or connect the instrument by following the procedure of each measurement example (or procedure steps).

Auto power save function

- Before shipping (In the default setting), the auto power save function is set to enabled. If the instrument has not been operated for approx. 15 minutes, it enters the sleep mode. (When the instrument is in the sleep mode, press any key or turn the rotary switch to recover from the sleep mode.)
When the sleep mode continues for approx. 45 minutes, the power turns off automatically.
- To recover from the power off state, set the rotary switch to OFF and then turn on the power again.
- During current measurement, before setting the rotary switch to OFF, disconnect the test leads. If the rotary switch is forcibly turned, the shutter may be damaged.
- If the instrument will be used for an extended period of time, disable the auto power save function. (p. 76)
- After use, set the rotary switch to OFF. The auto power save function consumes a small amount of current.

Numerical value display with no input

When the measurement terminal is open during DC voltage (DCV) measurement or AC voltage (ACV) measurement in the 60 mV range or 600 mV, a random value is displayed. This does not indicate a malfunction of the instrument. When the probe is connected to the measurement target, a normal numerical value is displayed. A high-input impedance voltmeter is used in the instrument for highly sensitive measurement. Consequently, external noise, such as inductive noise, appears as a numerical value.

3.2 Measuring Voltage

AC voltage, DC voltage, synthesized voltage of DC and AC, and voltage of AC and DC components can be measured. Furthermore, the maximum, minimum, and peak (instantaneous) values of measured values can be checked. (p. 67)

Before measurements

WARNING



If the instrument is used in locations where the rating indicated on the instrument or probes is exceeded, the instrument may be damaged resulting in personal injury. Do not use the instrument in such locations. See “Measurement categories” (p. 10).

The auto-range function of this instrument automatically selects the optimum measurement range. To change the range arbitrarily, use the manual range. (p. 61)

Measuring AC voltage

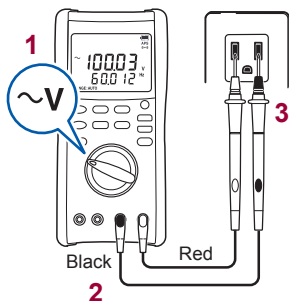

Measure the AC voltage.

Measure the frequency simultaneously.

The measured value is a true RMS.

(p. Appx.1)

If the input voltage is lower than each range's accuracy guarantee range, the instrument may display zero. Choose an appropriate range for the input voltage to measure it.

Measuring DC voltage

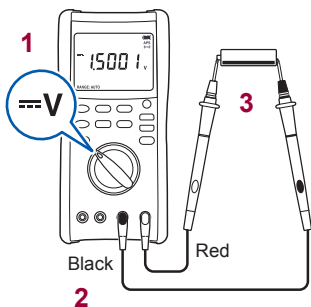

Measure the DC voltage.

Measuring synthesized voltage of DC and AC

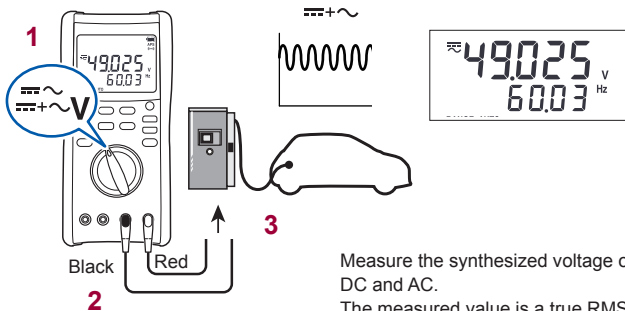

Measure the synthesized voltage of DC and AC.

The measured value is a true RMS.
(p. Appx.1)

It is also possible to check the AC or DC components individually. (p. 43)

If the input voltage is lower than each range's accuracy guarantee range, the instrument may display zero.
Choose an appropriate range for the input voltage to measure it.

Measuring voltage of DC and AC components

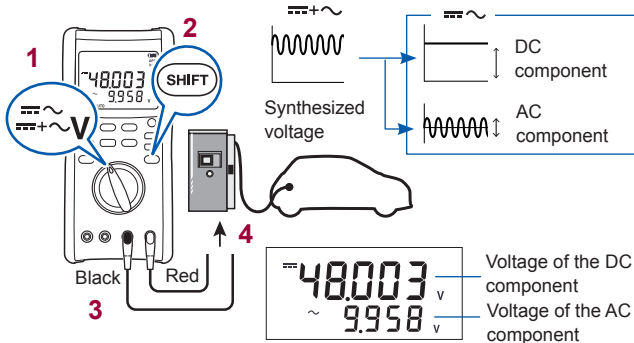

3.3 Measuring Frequencies

During voltage/current measurement of AC, the frequency can be checked in the sub display. It is not possible to change the frequency range.



- If signals out of the range of frequency measurement are measured, [----] appears. Be aware of it.
- The sensitivity of the frequency measurement is regulated by range. (Minimum sensitivity voltage (p. 98), Minimum sensitivity current (p. 98)) When the value is less than the minimum sensitivity voltage (current), the indicated value may fluctuate. When the voltage (current) range is lowered, the value stabilizes. This does not apply to cases where the value fluctuates due to noise.
- During the measurement of low frequency, if the auto range does not stabilize and frequency cannot be measured, fix the range and measure again.

3.4 Decibel Conversion (dBm/dBV)

The result of the AC voltage measurement is decibel-converted for the standard and then displayed. For details on the conversion formula, see “Decibel conversion measurement” (p. 99).

dBm For the voltage measurement, the “power ratio” for power 1 mW by the standard resistance is decibel-converted and then displayed. (Cable loss)

dBV For the voltage measurement, the “voltage ratio” for the standard voltage 1 V is decibel-converted and then displayed. (Voltage gain)

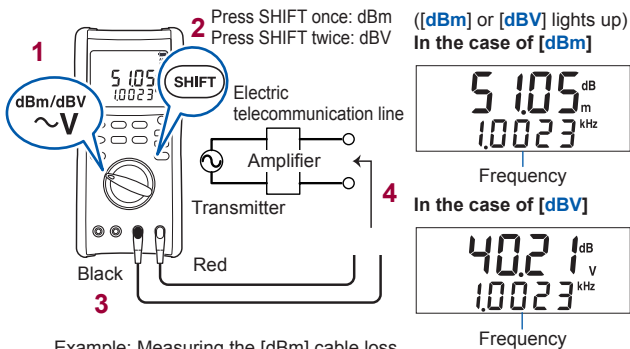

Changing the standard impedance of the dBm conversion



Standard impedance selection range (p. 99)

- 1 Turn on the power while pressing .
- 2 / (Select a desired value.)
- 3 (Confirm the value.)

The measurement display reappears. Even after the power is turned off, the setting is retained.

3.5 Checking Continuity

The input short circuit is detected and informed via a buzzer and red backlight.

⚠ WARNING



Before measuring, be sure to turn off the power to the measurement circuit. Otherwise, electric shock may occur or the instrument may be damaged.

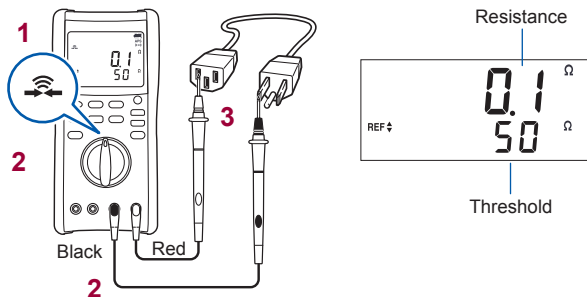

Changing thresholds

Use \blacktriangle / \blacktriangledown to change a threshold. Even after the power is turned off, the setting is retained.

Detection	Threshold				Measurement result	
	20 Ω (default)	50 Ω	100 Ω	500 Ω	Buzzer	Red backlight
Open detection	220 Ω or more	250 Ω or more	300 Ω or more	600 Ω or more	Does not sound	Turns off
Short circuit detection	20 Ω or less	50 Ω or less	100 Ω or less	500 Ω or less	Sounds	Turns on

Once continuity has been detected, the judgment will continue to be in effect until the reading reaches or exceeds the predetermined resistance value.

3.6 Measuring Diode

The forward voltage of the diode is measured. If the forward voltage of the diode is the threshold or less, it is informed via a buzzer and red backlight.

⚠ WARNING



Before measuring, be sure to turn off the power to the measurement circuit. Otherwise, electric shock may occur or the instrument may be damaged.

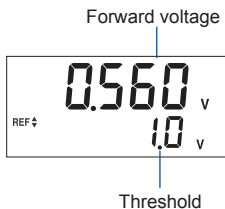
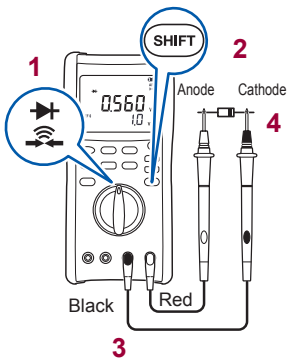

In the case of the opposite connection



Changing thresholds

Use / to change a threshold.

Threshold: 0.15 V/0.5 V (default)/1 V/1.5 V/2 V/2.5 V/3.0 V
Even after the power is turned off, the setting is retained.

3.7 Measuring Resistance

Resistance is measured.

To measure low resistance accurately, it's necessary to cancel the test leads' resistance component. Zero-adjust the indicated value in advance using the relative value display (relative function).

See "4.7 Checking the Relative Value/Performing Zero Adjustment" (p.69)

⚠ WARNING



Before measuring, be sure to turn off the power to the measurement circuit. Otherwise, electric shock may occur or the instrument may be damaged.

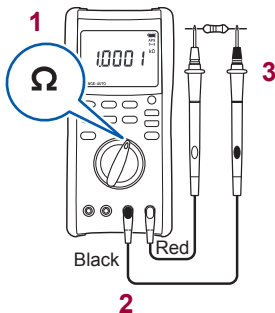

Measurement of inductors, including motors and transformers, may cause unstable auto-range switching. In such a case, set the range manually (p.61). Moreover, if a capacitive component is connected across the object under measurement, its measured value may be incorrect.

The open terminal voltage is approx. 2.5 V or less. The measurement current (DC) varies depending on the range. (p. 92)
To avoid damage to the measurement object, check the specifications before use.

3.8 Measuring Temperatures

Using our optional DT4910 Thermocouples (K), temperatures can be measured.

CAUTION



To avoid damage to the instrument, do not input any voltage or supply current to the thermocouple.

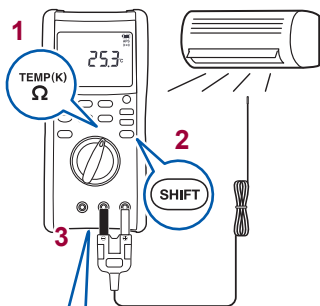

When a breaking state of the Thermocouples (K) is detected

OPEN

Checking the temperature change

Check the following values.

- Relative value display (p. 69)
- Maximum/Minimum value display (p. 67)

Changing the temperature units

Celsius and Fahrenheit can be switched. (p. 81)

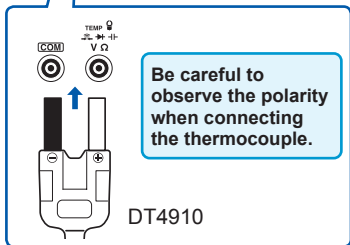

When measuring temperatures with the thermocouple applied to the surface of the measurement object

Clean the surface so that the thermocouple can make contact with the object securely.

If no numeric value is displayed after the thermocouple is attached ([OPeN] is displayed):

The instrument or thermocouple may be malfunctioning. Check this with the following procedure.

1 Short-circuit the V and COM terminals of the instrument using the test leads.

The ambient temperature is displayed.	To step 2
---------------------------------------	-----------

The ambient temperature is not displayed.	The instrument is malfunctioning. Send it for repair.
---	---

2 Connect the thermocouple in the correct direction.

[OPeN] remains displayed.	The thermocouple may be malfunctioning (blown). Replace the thermocouple with a new one.
---------------------------	---

3.9 Measuring Electrostatic Capacities

The capacity of the capacitor is measured.

WARNING



Before measuring, be sure to turn off the power to the measurement circuit. Otherwise, electric shock may occur or the instrument may be damaged.



Do not measure the capacitor which has been charged.

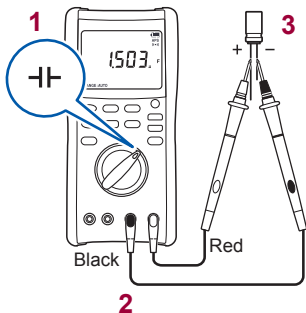

- **When measuring the polar capacitor**
Connect the V terminal (red test lead) to the + terminal of the capacitor and the COM terminal (black test lead) to the - terminal.
- For components on a circuit board, measurement may not be possible due to the effect of the peripheral circuit.
- The capacity values may vary depending on the measurement range. All values are true values.

3.10 Measuring Conductances (DT4282)

The resistance is measured and the inverse number is displayed (Unit: nS, nano-siemens). When the resistance is excessively large, it is used.

Example: When the resistance is $50\text{ M}\Omega$, $1/50\text{ M}\Omega = 20\text{ nS}$.
($M = 10^6$, $n = 10^{-9}$)

When the terminal is open, 0 nS appears.

⚠ WARNING



Before measuring, be sure to turn off the power to the measurement circuit. Otherwise, electric shock may occur or the instrument may be damaged.

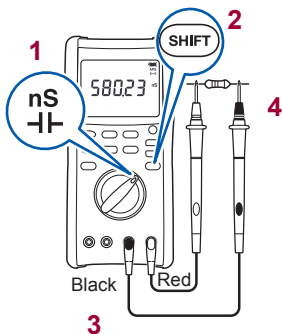

The open terminal voltage is approx. 2.5 V or less. The measurement current (DC) is approx. 96 nA. (p. 93)
To avoid damage to the measurement object, check the specifications before use.

3.11 Measuring Current

DC/AC is measured.

DANGER





- Do not input any voltage to the current measurement terminals. Doing so may result in short circuit accidents.
- To avoid electrical accidents, turn off the power to the circuit before measuring and then connect the test leads.

Measuring DC/AC

Function

 is used to toggle between DC and AC.



μA Selected to measure 6000 μA or less.

 → 

mA Selected to measure 600 mA or less.

 →  → 4-20mA *

A Selected to measure 10 A or less.
(DT4282)

 → 

* The 0-20 mA input can be selected via the power-on option. (p. 83)

When measuring an unknown current

Set to the high range (**mA** for the DT4281, **A** for the DT4282).

DT4281, DT4282

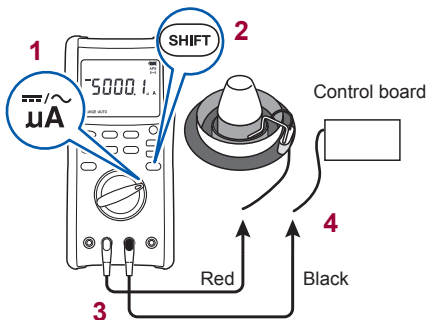

Example: Measuring the current of the burner flame (μA)

The measured current value of the burner flame varies with the input impedance of the instrument.
The μA input impedance of this instrument is approx. $100\ \Omega$.

DT4282

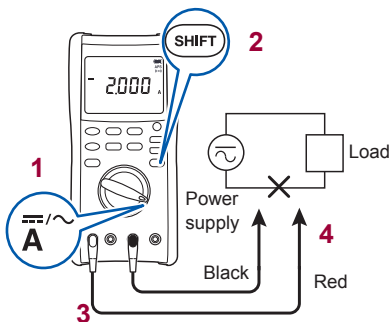

For AC current measurement, the instrument may display zero if the input current is lower than each range's accuracy guarantee range.
Choose an appropriate range for the input current to measure it.

3.12 Measuring AC Using Clamp-on Probe (DT4281)

The current is measured using our optional clamp-on probe (9010-50, 9018-50, 9132-50). To connect to this instrument, the 9704 Conversion Adapter is required. Before using the clamp-on probe, be sure to read the Instruction Manual which accompanies the optional clamp.

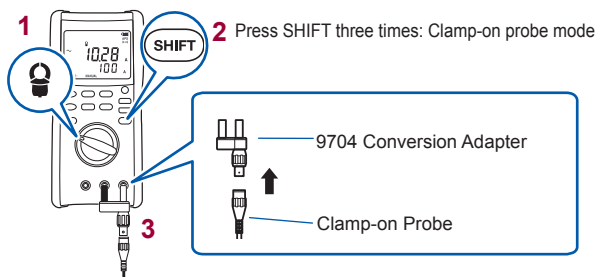

Set the clamp-on probe and the instrument to the same range.

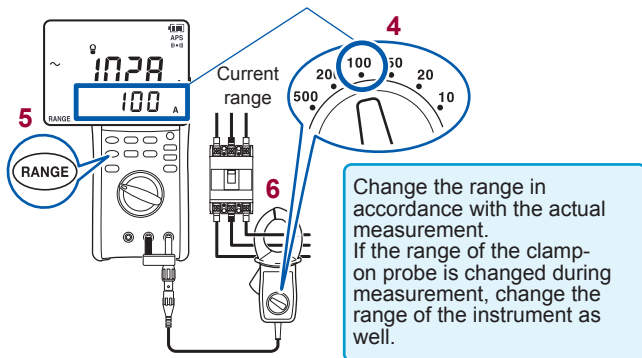

When clamping a cable

Attach the clamp around only one conductor.

Single-phase (2-wire) or three-phase (3-wire) cables clamped together will not produce any reading.

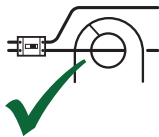
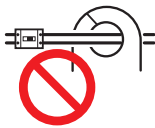
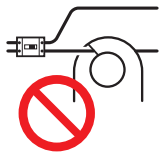
**OK****NO****NO****When **OVER** blinks**

The measured value exceeds maximum display counts. Increase the range.

3

If the input current is lower than each range's accuracy guarantee range, the instrument may display zero.

3.13 4-20 mA (0-20 mA) % Conversion

The 4-20 mA (or 0-20 mA) signal of the instrumentation system can be converted to 0% to 100% and checked.

- 4 mA - 20 mA → 0% - 100%
(An input exceeding 20 mA is displayed up to a maximum of 350%.)
- 0 mA - 20 mA → 0% - 100%
(An input exceeding 20 mA is displayed up to a maximum of 300%.)

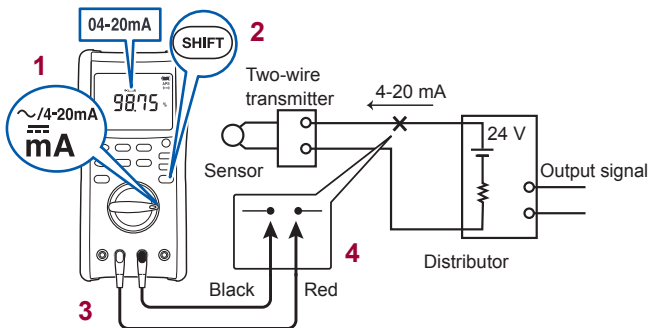

Changing to the 0-20 mA signal

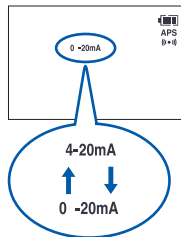

- 1 Turn on the power while pressing .
- 2 / (Select a desired value.)
- 3 (Confirm the value.)

The measurement display reappears. Even after the power is turned off, the setting is retained.

3.14 Measuring DC Voltage with the DC High Voltage Probe

Use of the P2000 DC High Voltage Probe (optional) allows you to measure DC voltage of up to 2000 V (CAT III 2000 V, CAT IV 1000 V), such as open voltage of solar panels. Before using the DC High Voltage Probe, be sure to read the instruction manual that comes with the DC High Voltage Probe.

For details, please visit our website.

WARNING



Do not measure voltage that exceeds 2000 V DC. Do not measure AC voltage. Doing so could damage the instrument and the P2010 or P2000, causing bodily injury.



Use the P2010 or P2000 to measure voltage that exceeds 1000 V DC. Use of other probes could cause the operator to experience an electric shock.

CAUTION



When using the L4943 Connection Cable Set (included in the P2000), do not subject the cable or plug to a mechanical load. Doing so could cause the cable to become disconnected or result in damage to the cables and plugs.

Using P2010

- 1** Rotate the rotary switch.

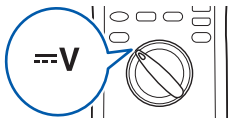

- 2** Set the range to the 60 V or 600 V range.

See “Measuring with the manual range” (p. 61).

- 3** Connect the P2010 DC High Voltage Probe to the measurement terminals of the instrument.

Connect the instrument's COM and V terminals to the P2010's OUTPUT L (black) and OUTPUT H (red) terminals, respectively.

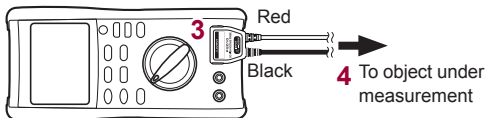

- 4** Connect the P2010's probes to the object under measurement.

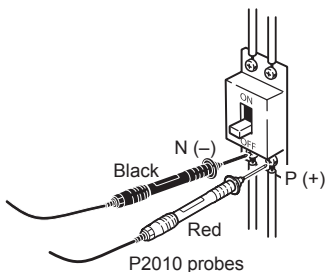

- 5** Check the measured value.

The actual value is obtained by multiplying the displayed measured value by 10.

Using P2000

- 1** Rotate the rotary switch.

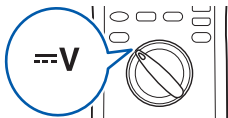

- 2** Set the range to the 60 V or 600 V range.

See “Measuring with the manual range” (p. 61).

- 3** Connect the P2000 DC High Voltage Probe to the measurement terminals of the instrument.

Connect the instrument's COM and V terminals to the P2000's OUTPUT L (black) and OUTPUT H (red) terminals, respectively, with the L4943 or L4930.

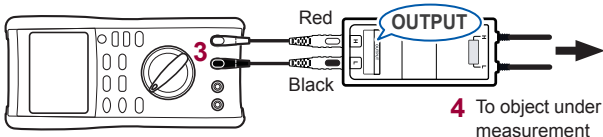

- 4** To object under measurement

- 4** Connect the P2000's probes to the object under measurement.

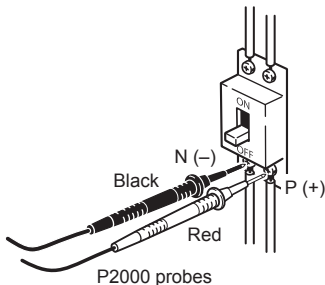

- 5** Check the measured value.

The actual value is obtained by multiplying the displayed measured value by 10.

4.1 Selecting the Measurement Range

Auto or Manual range can be selected. In the case of measurement where the desired range can be selected, [RANGE:] lights up in the bottom left of the display.

- Auto range Sets the optimum range automatically in accordance with the actual measurement.
- Manual range Sets the range and fixes it specifically.

Measuring with the auto range

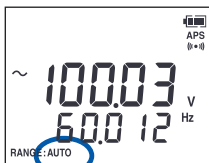

When the manual range is set, pressing **AUTO RANGE** for at least 1 second changes to the auto range. The instrument automatically selects the optimum measurement range.

Measuring with the manual range

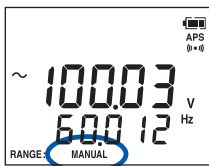

Press **AUTO RANGE**.

Each time the key is pressed, a higher range is specified.

When the key is pressed at the highest range, the lowest range is specified once again.

Example: When measuring the AC voltage

60 mV → 600 mV ----> 600 V → 1000 V

When the measurement function is switched using the rotary switch or **SHIFT**, or when the peak measurement is canceled, the auto range is enabled.

Range display list

ACV, DCV	60 mV, 600 mV, 6 V, 60 V, 600 V, 1000 V
DC+ACV	6 V, 60 V, 600 V, 1000 V
Ω	60 Ω, 600 Ω, 6 kΩ, 60 kΩ, 600 kΩ, 6 MΩ, 60 MΩ, 600 MΩ
- - (Electrostatic capacity)	1 nF, 10 nF, 100 nF, 1 μF, 10 μF, 100 μF, 1 mF, 10 mF, 100 mF
DCA, ACA	600 μA, 6000 μA, 60 mA, 600 mA, 6 A ^{*2} , 10 A ^{*2}
AC clamp^{*1}	10 A, 20 A, 50 A, 100 A, 200 A, 500 A, 1000 A
PEAK (DCV)	6 V, 60 V, 600 V, 1000 V
PEAK (ACV)	18 V, 180 V, 1500 V
PEAK (DC+ACV)	18 V, 180 V, 1500 V
PEAK (DCA/ACA)	1200 μA, 12000 μA, 120 mA, 1200 mA, 12 A ^{*2} , 15 A ^{*2}
PEAK (AC clamp^{*1})	30 A, 60 A, 150 A, 300 A, 600 A, 1500 A, 3000 A

*1: Only the DT4281

*2: Only the DT4282

4.2 Retaining the Measured Value

The measured value is retained manually or automatically.

- **Manually** When **HOLD** is pressed, the measured value is retained.
- **Automatically** When **HOLD** is pressed and held for at least 1 second, auto mode starts. When the measured value stabilizes, it is retained.

Retaining the measured value manually (HOLD)

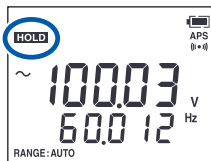

To retain the measured value, press **HOLD**. (**HOLD** lights up and the measurement value is retained.)

To cancel the hold state, press it again. (**HOLD** goes off.)

4

Automatically retaining the measured value when the value stabilizes (AUTO HOLD)

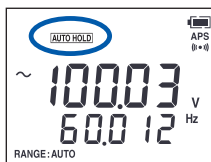

Press **HOLD** for at least 1 second.

(**AUTO HOLD** lights up.)

When the measured value stabilizes, a beeping sound is generated and the value is retained.

(**HOLD** lights up.)

If **HOLD** is pressed again, or the input signal exceeds the dead zone threshold again (see table on the next page), or when the range is switched internally and the measured value is stabilized once again, the hold state is canceled. (**HOLD** goes off.)

To disable the auto hold function, press it for at least 1 second again. (**AUTO HOLD** goes off.)

- If the input signal is too small for the relevant range (dead zone threshold p. 64), the measured value cannot be automatically retained.
- If the difference between the current and previous measured values remains less than the counts in the stable field of the table below, the instrument determines the current value has stabilized.

Dead zone threshold

Function	Stable (count)	Dead zone threshold (count)
AC voltage	1200, 200 (1000 V range)	1200, 200 (1000 V range) *
DC voltage	1200, 200 (1000 V range)	1200, 200 (1000 V range) *
DC voltage + AC voltage	1200, 200 (1000 V range)	1200, 200 (1000 V range)
Continuity check	100	5900
Diode test	80	3520
Resistance	1200, 120 (60 M Ω /600 M Ω range)	58800, 5880 (60/600 M Ω range)
Conductance	1200	1200
DC	μ A	1200
	mA	1200
	A	1200, 200 (10 A range)
AC	μ A	1200
	mA	1200
	A	1200, 200 (10 A range)
AC (clamp input)	5% of the range	5% of the range

* No function is available for the mV range.

4.3 When the Measured Value Fluctuates (SLOW)

When the measured value fluctuates and cannot be read, it is possible to stabilize the value. (When **SLOW** is lit)

- When **SLOW** is off (normal): refer to the display update rate (p.86) (Default setting)
- When **SLOW** is lit (slow): five times normal (average of 5 times)

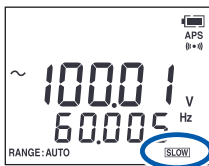

Press ^{SLOW} **MEM** for at least 1 second.
(**SLOW** lights up.)

To cancel the state, press it for at least 1 second again.
(**SLOW** goes off.)

When the measurement function is switched using the rotary switch or **SHIFT**, the SLOW setting is disabled.

4.4 Removing the Harmonic Components of the Inverter (FILTER)

WARNING



To prevent electric shock, before setting the filter function, confirm if there is a voltage or not with the filter function disabled (OFF).

Remove the harmonic components when measuring the inverter output.

This function can be used when measuring the AC voltage or AC+DC voltage. The cut-off frequency is 630 Hz.

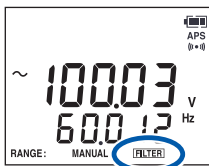

Press  for at least 1 second.

( lights up.)

To cancel the state, press it for at least 1 second again.

( goes off.)

Only 600V/1000V range.

When the measurement function is switched using the rotary switch or **SHIFT**, the filter function is canceled.

When measuring voltage with a 400 Hz fundamental frequency (such as that on an aircraft), be aware that the FILTER function may cause attenuation and the indicated voltage may be 20% lower than the actual voltage.

The characteristics of the FILTER function (low pass filter) are shown in the graph.

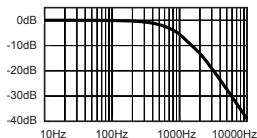

4.5 Checking the Maximum/Minimum Value (MAX/MIN)

The maximum/minimum value after start of the measurement can be checked.

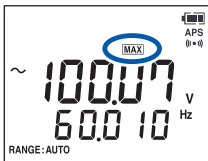

Press **MAX/MIN**.

Each time the key is pressed, the display is changed in the order of the maximum value (MAX), minimum value (MIN), and current value.

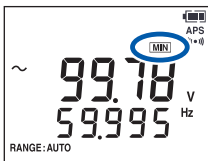

A buzzer sounds when the maximum value is updated with MAX displayed or the minimum value is updated with MIN displayed.

4

The maximum and minimum values are for the displayed value; they do not relate to peak values such as AC signals. The main and sub displays update their maximum and minimum values individually.

Clearing the existing maximum/minimum value

When MAX or MIN appears, press **CLEAR**.

Both maximum and minimum values are cleared.

After this, the maximum and minimum measurement values after clearing the previous ones are retained.

When saving to memory, only the value displayed on the screen (current value, maximum value, or minimum value) can be saved.

4.6 Checking the Peak Value (V • A PEAK)

After starting the voltage/current peak measurement, the maximum/minimum instantaneous value can be checked.

The peak measurement can be performed only with the manual range. Press **RANGE** to select the appropriate range before starting the measurement. (For the range configuration and display range, see page 90)

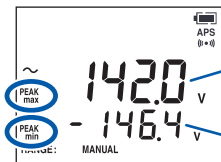

Maximum instantaneous value
Minimum instantaneous value

Press **V-A PEAK**.

The maximum/minimum instantaneous value can be retained, from the point at which **V-A PEAK** is pressed.

To cancel the display of the peak value, press it again.

- A buzzer sounds when PEAKmax or PEAKmin is updated.
- If you start peak measurement using the 60 mV range or 600 mV range, such a range switches over to the 6 V range.

Clearing the maximum/minimum instantaneous value

Press **CLEAR**.

The maximum/minimum instantaneous value can be displayed, from the point at which **CLEAR** is pressed.

4.7 Checking the Relative Value/ Performing Zero Adjustment

The relative value comparing to the standard value can be checked (relative function).

It can also be used as the zero adjustment function.

Zero adjustment eliminates the influences of the wiring resistance (resistance measurement) and the wiring capacity (capacitor measurement).

When the following measurement function is selected, this function is disabled.

Peak measurement, Continuity, Diode, dBm/dBV, 4-20 mA

The measurement range cannot be changed when [REL] is lit. To change the range, press **REL** for at least 1 second to reset the REL function.

4

Checking the relative value (REL)

Example 1: DC voltage measurement

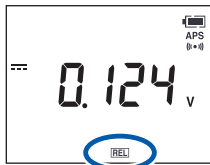

When the standard value is measured,

press **REL** (MAX/MIN) for at least 1 second
([REL] lights up).

To cancel the state, press it for at least 1 second again. ([REL] goes off.)

Example 2: Temperature measurement

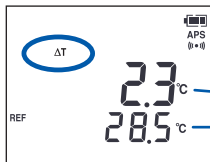

When measuring temperature, [REF] lights up and a standard temperature appears in the sub display.

— Deviation from the standard temperature

— Standard temperature

Performing zero adjustment

When performing zero adjustment, the condition of the test leads varies depending on the measurement function.

Perform zero adjustment, referring to the table below.

Measurement function	V, A, Ω	$\text{--}\text{H}$, nS
Condition of the test leads	Short circuit	Open

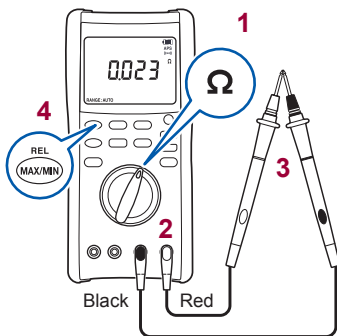

Example 1: Resistance measurement

- 1** Select the measurement function.
- 2** Connect the test leads to the measurement terminals.
- 3** Allow the test leads to short circuit.

- 4** Press **REL MAX/MIN** for at least 1 second.

(After zero adjustment: 0.000 Ω)

- 5** Measure the resistance.

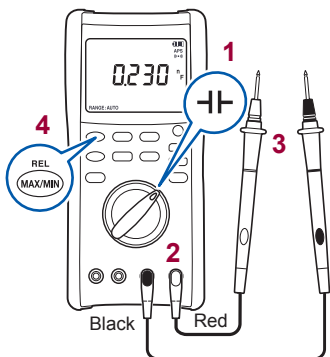

Example 2: Capacitor measurement

- 1** Select the measurement function.
- 2** Connect the test leads to the measurement terminals.
- 3** Allow the test leads to open.

- 4** Press **REL MAX/MIN** for at least 1 second.

(After zero adjustment: 0.000 nF)

- 5** Measure the capacitor.

4.8 Using the Memory Function

The measurement result can be saved and read using the memory function. Up to 400 data can be saved. Data can also be deleted arbitrarily.

The saved data can be imported to the PC using the DT4900-01 Communication Package (optional).

Saving the measured value (MEM)

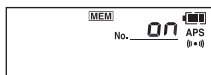

Memory No.

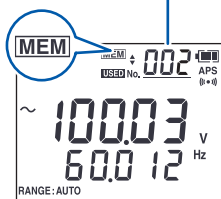

1 Press **MEM** (**MEM** lights up).

Memory mode starts.

This function applies until the power is turned off.

The memory No. appears (only for the measurement which can be saved).

2 Select the memory No. to be saved using **▲** / **▼**.

When the key is pressed and held, the memory No. can be incremented/decremented faster.

3 Press **MEM** to save the measured value.

When the measured value is saved, the memory No. for which the value is to be saved next appears.

Even when the power is turned off, the memory data are retained.

- If the memory No. for which the data have already been saved is selected, [USED] appears.
- When MEM is pressed, the data are overwritten.
- When the value is saved with memory No. "400" displayed, a buzzer sounds and "FULL" appears in the display, and then "001" reappears.
- When [READ] (data reading) is displayed, it is not possible to save the value.
- The current value, maximum value (MAX), minimum value (MIN), instantaneous maximum value (Peak max), and instantaneous minimum value (Peak min) cannot be saved simultaneously. Only the displayed numeric value can be saved.
- The continuity check data and the diode test data cannot be saved.

When both hands cannot be used during measurement

Enable the auto hold function. After the measured value is retained automatically, press MEM to save the data.

Items to be saved per data

- Function
- Measurement range
- Measured value in the main display
- Measured value in the sub display
- Whether or not the REL function is executed
- Filter ON/OFF

Reading the memory data (READ)

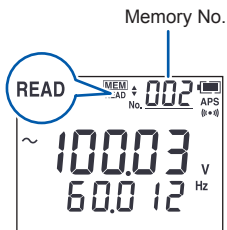

- 1 Press **READ** (READ lights up).

Read mode starts.

- 2 Select the desired memory No. using **▲** / **▼**.

Only the memory Nos. corresponding to saved data are displayed.

Canceling the read mode

Press **READ** again or turn the rotary switch.
(READ goes off.)

4

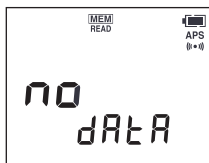

When no memory data exist

The relevant message appears and then the measurement display reappears.

Clearing the memory data (CLEAR)

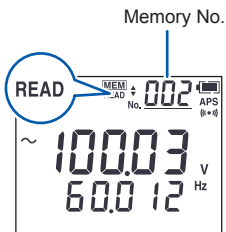

- 1 Press **READ** (**READ** lights up).

Read mode starts.

- 2 Select the No. to be cleared using **▲** / **▼**.
- 3 Press **CLEAR**.

Clearing all memory data



- 1 Turn on the power while pressing **CLEAR**.

The relevant message appears in the display.

- 2 Press **CLEAR** again within 3 seconds.

All memory data are now cleared.

When 3 seconds elapse without pressing **CLEAR**, all memory data are not cleared and the measurement display reappears.

4.9 Muting the Buzzer

The buzzer sound can be disabled.

Note, however, that the buzzer cannot be muted in the following cases. Continuity check, diode test, and overload warning (only for the maximum value)

Turn on the power while pressing .

When  is released, the measurement display appears ((••)) goes off).

Canceling the buzzer mute function

Turn on the power again while pressing .

When  is released, the measurement display appears ((••)) lights up). Even after the power is turned off, the buzzer setting is retained.

4.10 Turning On the Backlight

The backlight can be turned on/off by pressing .

When PC communication is started, the backlight is turned off forcibly.

Enabling/disabling the automatic deactivation of the backlight

Turn on the power while pressing .

Even after the power is turned off, the automatic backlight deactivation setting is retained.

Automatic deactivation

Enable

```
on
  bL - A
```

When the automatic deactivation setting is enabled (on), the backlight goes off automatically, approximately 40 seconds after the backlight comes on.

Disable

```
off
  bL - A
```

4.11 Using the Auto Power Save (APS)

The auto power save function saves on power consumption. If the instrument has not been operated for approx. 15 minutes, it enters the sleep mode. (When the instrument is in the sleep mode, press any key or turn the rotary switch to recover from the sleep mode.) When the sleep mode continues for approx. 45 minutes, the power turns off automatically.

Before shipping (as one of the default settings), the auto power save function is set to enabled. (APS lights up)

It is also possible to disable the auto power save function.

At 30 seconds before the instrument enters the sleep mode, the APS blinks to indicate its status. To continuously use the instrument, press any key or turn the rotary switch.

After use, set the rotary switch to OFF. The auto power save function consumes a small amount of current.

Recovering from the power off state

Set the rotary switch to OFF and turn on the power again.

(When the current measurement is used, disconnect the measurement cable and then turn on the power again.)

Disabling the auto power save function



Turn on the power while pressing



When  is released, the measurement display appears. (APS goes off.)

This function is disabled until the power is turned off.

4.12 Using Plus/Minus Judgment Function for Measurement Value

If the measured DC voltage falls below the following standard value, a buzzer sounds and the backlight lights up red.

This function is useful for checking for any incorrect connection of the DC power.

Standard value: -10 V or less

Measurement function: DCV

Enabling/disabling the Plus/Minus judgment function

Turn on the power while pressing **SHIFT**.

The setting will be saved even when the power is turned off. ON and OFF is switched at each operation.

4.13 Communicating with PC

Using the optional DT4900-01 Communication Package, it is possible to transmit data to the PC or to control the instrument. USB Driver, PC software, and Remote Operation Manual can be downloaded from Hioki's website.

See "Information on download site" (p. 1)

Install the special software on the PC.

(See the Instruction Manual included in the communication package.)
Dedicated Software (p.Appx.3)

Attaching the USB cable to the instrument (p. 79)

Connect to the PC.

The virtual COM ports of the PC can be used as the USB interface.

- Communication method: Start-stop system, half-duplex transmission
- Baud rate: 19200 bps fixed
- Data bit length: 8 bits
- Stop bit: 1 bit
- Parity: None
- Flow control: None
- Delimiter: CR+LF

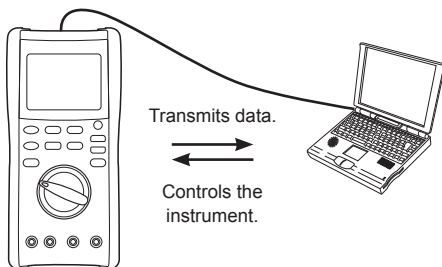

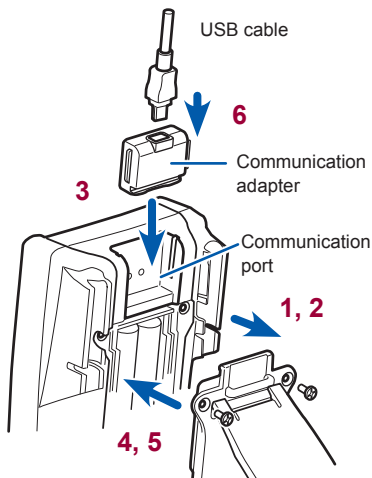

Attaching the communication adapter to the instrument



- 1** Using a Phillips screwdriver, remove the screws (2 locations) from the battery cover.
- 2** Remove the battery cover.
- 3** Attach the communication adapter.
- 4** Reattach the battery cover.
- 5** Secure the battery cover with the screws.
- 6** Connect the USB cable to the communication adapter.

4

- Connect the cables, being careful to orient each cable correctly.
- During communication,  appears in the display.
- When  is lit, the operation keys of the instrument is disabled.
- During communication, do not disconnect the USB cable. Disconnecting the cable stops the communication. In that case, a warning is displayed by the PC software. Connect the cable again.
- It is possible to use the instrument while the communication adapter is attached, however, the communication adapter is excluded from the drop-proof.

4.14 Setting and Checking the System

Checking that all indicators are displayed

Check that there is no missing indicator.

If any indicator is missing, stop using the instrument and send it for repair.

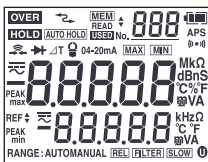

Turn on the power while pressing



When **V-A PEAK** is released, the measurement display appears.

Checking the software version of the instrument

For repair or calibration, check the version if necessary.

Example: Ver 1.00

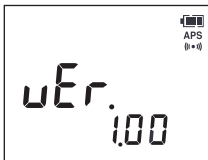

Turn on the power while pressing



When **RANGE** is released, the measurement display appears.

Changing the temperature display unit

The units of temperature ($^{\circ}\text{C}$ or $^{\circ}\text{F}$) can be changed.

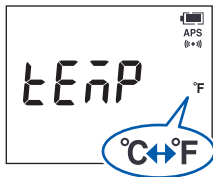

(Display: tEMP)

- 1 Turn on the power while pressing **REL** **MAX/MIN** and **▲** simultaneously.
- 2 Press **REL** **MAX/MIN** for at least 3 seconds.
- 3 Change the unit of the temperature using **▲** / **▼**.
- 4 Press **HOLD** to determine the setting.

4

After a few moments, the measurement display reappears.

The setting of the temperature unit is retained even after the power is turned off.

4.15 Resetting the System

The system is returned to the state before shipping. The power-on option setting is also reset.

The memory data are not reset. To clear the memory data, clear the data individually for each memory No. (p. 74) or clear all data (p. 74). *The temperature unit is not reset, either.*

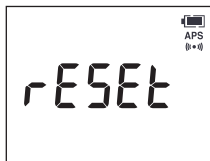

- 1** Turn on the power while pressing **CLEAR** and **SHIFT**.
- 2** Within 3 seconds, press **CLEAR** again.

After **[CLR]** blinks, the system returns to the state before shipping.

If the instrument is not operated for 3 seconds, the system is not reset but the measurement display reappears.



















Table of default settings





















Setting item	Default setting	Display
Filter function	Disabled	
Relative function	Disabled	
Display update	Normal	
Display hold	Disabled	
Range	AUTO	[RANGE:AUTO] is lit.
Auto hold	Disabled	
Maximum/Minimum value	Disabled	
Peak value	Disabled	
Auto power save function	Enabled	[APS] is lit.
Automatic backlight deactivation	Off	
Buzzer	Enabled	[((••))] is lit.
% conversion	4-20 mA	
dBm standard impedance	600 Ω	
Temperature display unit	°C	
Plus/Minus Judgment Function for Measurement Value	Disabled	

4.16 Power-on Option Table

The settings in the instrument can be changed or checked. After changing the setting, the measurement display then reappears.

- +  Turn on the power while pressing the operation key.
(Turn the rotary switch from OFF.)

Setting change	Method	Ref.
Canceling the auto power save function (APS)	 +  ([APS] goes off.)	p. 76
Buzzer (ON/OFF)	 +  ([(•••)] lights up/goes off.)	p. 75
Automatic backlight deactivation setting	 +  Automatic deactivation disabled: [oFF], [bL-A] Automatic deactivation enabled: [on], [bL-A]	p. 75
Clearing all memory data	 +  →  Press this within 3 seconds.	p. 74
System reset	 +  +  →  Press this within 3 seconds.	p. 82
Standard impedance setting (dBm measurement)	 +  →  /  →  Select the desired setting. Confirm the change.	p. 44

Setting change	Method	Ref.
Switching to 4-20 mA/ 0-20 mA	 +  →  /  →  <p>Select the desired setting. Confirm the change.</p>	p. 56
Displaying all indicators	 + 	p. 80
Checking the version	 + 	p. 80
Switching the temperature unit	 +  +  →  → 3 seconds or more  /  →  Select the desired setting. Confirm the change.	p. 81
Displaying the serial number	 +  <p>Serial No. display (9 digits) 1st to 4th digits: Main display 5th to 9th digits: Sub display</p> <p>When  is released, the measurement display appears.</p>	
Enabling/ disabling the Plus/Minus judgment function	 + 	p. 77

5.1 Electrical Characteristics

AC measurement system True RMS measurement

Noise suppression

- NMRR DCV, -60 dB or less (50 Hz/60 Hz)
- CMRR DCV, -120 dB or less (DC/50 Hz/60 Hz, 1 k Ω unbalance)
- CMRR ACV, -60 dB or less (DC/50 Hz/60 Hz, 1 k Ω unbalance)

Response time

- Power ON time: within 2 seconds (When the range does not move until the measured value is displayed in the screen)

- | | *1 | *2 | |
|------------|------------------|--------------------|---|
| • DCV | Within 1 second | Within 1.5 seconds | (0 V \rightarrow 100 V auto range operation) |
| • ACV | Within 3 seconds | Within 8 seconds | (0 V \rightarrow 100 V auto range operation) |
| • Ω | Within 2 seconds | Within 3 seconds | (Infinity \rightarrow 0 Ω auto range operation) |
| • Ω | Within 2 seconds | Within 3 seconds | (0 Ω \rightarrow 30 M Ω auto range operation) |

*1: Until the value comes in the range of the accuracy specification

*2: Until the displayed value stabilizes (within ± 2 counts)

Display update rate	<ul style="list-style-type: none"> • V, Continuity, Ω, nS, Diode, Clamp, Frequency, A, dBm, dBV: 5 times/s • Electrostatic capacity 0.05 to 5 times/s (varies depending on the measured value) • Temperature 1 time/s (including disconnection check) • Peak measurement Up to 155 times/s when peak value is updated • DC+ACV 2.5 times/s
Input impedance	See "Accuracy Table" (p. 87).

Overload protection

Function	Overload protection
<ul style="list-style-type: none"> • ACV, dBm, dBV, Hz, AC clamp (DT4281) • DCV • DC+ACV, Hz 	1100 V DC/AC (50 Hz/60 Hz) or 2×10^7 V • Hz, whichever is the lower value <ul style="list-style-type: none"> • Voltage applied for 1 minute • Transient overvoltage 8000 V
<ul style="list-style-type: none"> • Continuity check, diode test • Ω, temperature (K) • Electrostatic capacity • nS (DT4282) 	1000 V DC/AC or 2×10^7 V • Hz, whichever is the lower value <ul style="list-style-type: none"> • Voltage applied for 1 minute • Current steady state under overload 15 mA or less • Current transient state under overload 0.8 A or less
<ul style="list-style-type: none"> • DCμA, ACμA, DCmA, ACmA, (4-20mA)%, Hz 	630 mA/1000 V fuse Breaking capacity 50 kA AC/30 kA DC
<ul style="list-style-type: none"> • DCA (DT4282), ACA (DT4282), Hz 	11 A/1000 V fuse Breaking capacity 50 kA AC/30 kA DC

5.2 Accuracy Table

Accuracy guarantee duration	1 year
Regulated power supply range	Until the power shutdown (3.8 V \pm 0.2 V)
Accuracy guarantee temperature and humidity range	23°C \pm 5°C (73°F \pm 9°F), 80% RH or less (non-condensing)
Temperature characteristic	Adds "Measurement accuracy \times 0.1/°C" (except 23°C \pm 5°C (73°F \pm 9°F))

Comply with the temperature characteristic in the applicable accuracy table if individually specified.

Other conditions: For information related to the L4931 extension cable set (coupled 2 cables, 3 m), see the accuracy table.

- rdg. (reading or displayed value): The value currently being measured and displayed on the measuring instrument.
- dgt. (resolution): The smallest displayable unit, i.e., the input value that causes the digital display to show a "1".

1 AC voltage (V AC, mV AC)

Range	Accuracy					
	20 to below 45 [Hz]	45 to 65 [Hz]	Over 65 to 1 k [Hz]	Over 1 k to 10 k [Hz]	Over 10 k to 20 k [Hz]	Over 20 k to 100 k [Hz]
60.000 mV	\pm 1.3% rdg. \pm 60 dgt.	\pm 0.4% rdg. \pm 40 dgt.	\pm 0.6% rdg. \pm 40 dgt.	\pm 0.9% rdg. \pm 40 dgt.	\pm 1.5% rdg. \pm 40 dgt.	\pm 20% rdg. \pm 80 dgt.
600.00 mV	\pm 1.3% rdg. \pm 60 dgt.	\pm 0.4% rdg. \pm 40 dgt.	\pm 0.6% rdg. \pm 40 dgt.	\pm 0.9% rdg. \pm 40 dgt.	\pm 1.5% rdg. \pm 40 dgt.	\pm 8% rdg. \pm 80 dgt.
6.0000 V	\pm 1% rdg. \pm 60 dgt.	\pm 0.2% rdg. \pm 25 dgt.	\pm 0.3% rdg. \pm 25 dgt.	\pm 0.4% rdg. \pm 25 dgt.	\pm 0.7% rdg. \pm 40 dgt.	\pm 3.5% rdg. \pm 40 dgt.
60.000 V	Not specified	\pm 0.2% rdg. \pm 25 dgt.	\pm 0.3% rdg. \pm 25 dgt.	\pm 0.4% rdg. \pm 25 dgt.	\pm 0.7% rdg. \pm 40 dgt.	\pm 3.5% rdg. \pm 40 dgt.
600.00 V	Not specified	\pm 0.2% rdg. \pm 25 dgt.	\pm 0.3% rdg. \pm 25 dgt.	\pm 0.4% rdg. \pm 25 dgt.	Not specified	Not specified
1000.0 V	Not specified	\pm 0.2% rdg. \pm 25 dgt.	\pm 0.3% rdg. \pm 25 dgt.	\pm 0.4% rdg. \pm 25 dgt.	Not specified	Not specified

Accuracy Table

Input impedance	1 M Ω \pm 4%, 100 pF or less
Crest factor	3 or less (For the 60.000 mV/ 600.00 mV/ 1000.0 V range, 1.5 or less for 100% of the input of the range 3 or less for 50% of the input of the range)
Accuracy guarantee range	5% or more of each range (less than 5% of each range is outside of the guaranteed accuracy) With the filter ON, the accuracy is specified in 100 Hz or less. Furthermore, 2% rdg. is added. Frequency range: 20 Hz to 100 kHz (A measured value outside of the accuracy guarantee range for frequency is also displayed.)
DC superimposition	<ul style="list-style-type: none"> • For the superimposition on 200 V DC or less, see the accuracy table. • For the superimposition on over 200 V DC to 500 V DC or less, 2% rdg. is added to the accuracy specification in 1 kHz or less. • For the superimposition on over 500 V DC, 10% rdg. is added to the accuracy specification in 1 kHz or less.

2 DC voltage (V DC, mV DC)

Range	Accuracy	Input impedance
60.000 mV	\pm 0.2% rdg. \pm 25 dgt. ^{*1}	1G Ω or more: 100 pF or less
600.00 mV	\pm 0.025% rdg. \pm 5 dgt. ^{*1}	1G Ω or more: 100 pF or less
6.0000 V	\pm 0.025% rdg. \pm 2 dgt.	11.0M Ω \pm 2%: 100 pF or less
60.000 V	\pm 0.025% rdg. \pm 2 dgt.	10.3M Ω \pm 2%: 100 pF or less
600.00 V	\pm 0.03% rdg. \pm 2 dgt.	10.2M Ω \pm 2%: 100 pF or less
1000.0 V	\pm 0.03% rdg. \pm 2 dgt.	10.2M Ω \pm 2%: 100 pF or less

*1: After leaving the instrument in an environment where the ambient air temperature has been stable for at least 30 minutes, allow the input to short circuit and activate the relative value display function (REL). The accuracy is then specified. After activating the REL, the temperature fluctuates within \pm 5°C.

3 DC+ACV measurement

Range	Accuracy					
	20 to below 45 [Hz]	45 to 65 [Hz]	Over 65 to 1 k [Hz]	Over 1 k to 10 k [Hz]	Over 10 k to 20 k [Hz]	Over 20 k to 100 k [Hz]
6.0000 V	±1.2% rdg. ±65 dgt.	±0.3% rdg. ±30 dgt.	±0.4% rdg. ±30 dgt.	±0.4% rdg. ±30 dgt.	±1.5% rdg. ±45 dgt.	±3.5% rdg. ±125 dgt.
60.000 V	Not specified	±0.3% rdg. ±30 dgt.	±0.4% rdg. ±30 dgt.	±0.4% rdg. ±30 dgt.	±1.5% rdg. ±45 dgt.	±3.5% rdg. ±125 dgt.
600.00 V	Not specified	±0.3% rdg. ±30 dgt.	±0.4% rdg. ±30 dgt.	±0.4% rdg. ±30 dgt.	Not specified	Not specified
1000.0 V	Not specified	±0.3% rdg. ±30 dgt.	±0.4% rdg. ±30 dgt.	±0.4% rdg. ±45 dgt.	Not specified	Not specified

Input impedance 1 MΩ ±4%, 100 pF or less

Crest factor 3 or less
(For the 1000.0 V range, 1.5 or less for 100% of the input of the range, 3 or less for 50% of the input of the range)

Auto range The range moves depending on the DC+AC calculation result.

Accuracy guarantee range 5% or more of each range (less than 5% of each range is outside of the guaranteed accuracy)
With the filter ON, the accuracy is specified in 100 Hz or less. Furthermore, 2% rdg. is added.
Frequency range: 20 Hz to 100 kHz (A measured values outside of the accuracy guarantee range for frequency is also displayed.)

Accuracy of DCV (main display) and ACV (sub display) when **SHIFT** is pressed during DC+ACV measurement

1. DCV (main display): the accuracy of 45 Hz to 65 Hz in the accuracy table is applied. Note however that 2%rdg. should be added when there is AC voltage superimposition less than 45 Hz.
2. ACV (sub display): according to the accuracy table

4 Peak measurement

See “4.6 Checking the Peak Value (V • A PEAK)” (p. 68)

(At the time of ACV, DCV, DC+ACV, Clamp, DC μ A, DCmA, DCA, AC μ A, ACmA, and ACA)

Main measurement	Signal width	Accuracy
DCV	4 ms or more (single)	$\pm 2.0\%$ rdg. ± 40 dgt. ^{*1}
	1 ms or more (repeated)	$\pm 2.0\%$ rdg. ± 100 dgt. ^{*2}
Other than DCV	1 ms or more (single)	$\pm 2.0\%$ rdg. ± 40 dgt. ^{*3, *4}
	250 μ s or more (repeated)	$\pm 2.0\%$ rdg. ± 100 dgt. ^{*4, *5}

*1: The accuracy is specified via the 5 V/4 ms single signal.

*2: The accuracy is specified at the peak value of 40000 counts/25 Hz sine wave.

*3: The accuracy is specified via the 5 V/1 ms single signal. (ACV, DC+ACV)

*4: The accuracy is specified at the peak value of the Max. counts/100 Hz sine wave in the main measurement range. (AC measurement)

*5: The accuracy is specified at the peak value of 40000 counts/100 Hz sine wave in the main measurement range. (DC measurement, 7 A/100 Hz for the 10 A range)

Maximum input range

Voltage measurement range	Peak measurement range		
	DCV	ACV	DC+ACV
6.0000 V	6.000 V	18.000 V	18.000 V
60.000 V	60.00 V	180.00 V	180.00 V
600.00 V	600.0 V	1500.0 V ^{*1}	1500.0 V ^{*1}
1000.0 V	1000 V	None	None

*1: Up to 1000 V for the RMS

Current measurement range	Peak measurement range
	DCA/ACA
600.00 μ A	1200.0 μ A
6000.0 μ A	12000 μ A
60.000 mA	120.00 mA
600.00 mA	1200.0 mA ^{*2}
6.0000 A (DT4282)	12.000 A ^{*3}
10.000 A (DT4282)	15.00 A ^{*3}

*2: Up to 600 mA for the RMS

*3: Up to 10 A for the RMS

AC clamp measurement range (DT4281)	Peak measurement range
10.00 A	30.00 A
20.00 A	60.00 A
50.00 A	150.0 A
100.0 A	300.0 A
200.0 A	600.0 A
500.0 A	1500 A
1000 A	3000 A

5 Continuity check

Range	Accuracy	Measurement current
600.0 Ω	$\pm 0.5\%$ rdg. ± 5 dgt.	640 μ A $\pm 10\%$

Open circuit voltage	2.5 V DC or less
Continuity threshold	20 Ω (default) /50 Ω /100 Ω /500 Ω
Threshold setting tolerance	$\pm 1\%$ setting ± 0.5 Ω
Response time	Open circuit or short circuit is detected for at least 10 ms.

6 Diode test

Range	Accuracy	Measurement current
3.600 V	±0.1% rdg. ±5 dgt.	1.2 mA or less

Open circuit voltage 4.5 V DC or less

If the reading is lower than the threshold during the forward connection, a buzzer sounds and red backlight comes on.

When the reading exceeds the threshold by 0.01 V or more during the forward connection, the buzzer stops and the red backlight turns off.

Forward threshold 0.15 V/0.5 V (default)/1 V/1.5 V/2 V/2.5 V/3 V)

Threshold setting tolerance ±1% setting ±0.005 V

7 Resistance (Ω)

Range	Accuracy	Measurement current
60.000 Ω	±0.3% rdg. ±20 dgt. ^{*1}	640 μ A ±10%
600.00 Ω	±0.03% rdg. ±10 dgt. ^{*1}	640 μ A ±10%
6.0000k Ω	±0.03% rdg. ±2 dgt. ^{*1}	96 μ A ±10%
60.000k Ω	±0.03% rdg. ±2 dgt. ^{*1}	9.3 μ A ±10%
600.00k Ω	±0.03% rdg. ±2 dgt.	0.96 μ A ±10%
6.0000M Ω	±0.15% rdg. ±4 dgt.	96 nA ±10%
60.00M Ω	±1.5% rdg. ±10 dgt. ^{*2}	96 nA ±10% ^{*5}
600.0M Ω	±3.0% rdg. ±20 dgt. ^{*2, *3} ±8.0% rdg. ±20 dgt. ^{*2, *4}	96 nA ±10% ^{*5}

*1: Allow the input to short circuit and activate the relative value display function (REL). The accuracy is then specified.

*2: The accuracy is specified for humidity 60%RH or less.

*3: The accuracy is specified for 200.00 M Ω or less.

*4: The accuracy is specified for more than 200.00 M Ω .

*5: The measurement current varies according to the resistance value of the object under measurement.

Open circuit voltage 2.5 V DC or less

8 Conductance (nS) (DT4282)

Range	Accuracy	Measurement current
600.00 nS	$\pm 1.5\%$ rdg. ± 10 dgt.	96 nA $\pm 10\%$

- The accuracy is specified for humidity 60%RH or less.
- For more than 300 nS, ± 20 dgt. is added.
- The accuracy is specified in 20.00 nS or more.

Open circuit voltage 2.5 V DC or less

9 Electrostatic capacity

Range	Accuracy ^{*2}	Open circuit voltage
1.000 nF	$\pm 1\%$ rdg. ± 20 dgt. ^{*1}	2.5 V DC or less
10.00 nF	$\pm 1\%$ rdg. ± 5 dgt. ^{*1}	2.5 V DC or less
100.0 nF	$\pm 1\%$ rdg. ± 5 dgt. ^{*1}	2.5 V DC or less
1.000 μ F	$\pm 1\%$ rdg. ± 5 dgt.	2.5 V DC or less
10.00 μ F	$\pm 2\%$ rdg. ± 5 dgt. ^{*3}	3.1 V DC or less
100.0 μ F	$\pm 2\%$ rdg. ± 5 dgt. ^{*3}	3.1 V DC or less
1.000 mF	$\pm 2\%$ rdg. ± 5 dgt. ^{*3}	2.1 V DC or less
10.00 mF	$\pm 2\%$ rdg. ± 5 dgt. ^{*3}	2.1 V DC or less
100.0 mF	$\pm 2\%$ rdg. ± 20 dgt. ^{*3}	2.1 V DC or less

*1: In the case of the 100 nF range or less, the accuracy is specified after the REL function is activated.

*2: The accuracy is specified in 0.22 nF or more.

*3: Adds "Measurement accuracy $\times 0.3/^{\circ}$ C" (except 23° C $\pm 5^{\circ}$ C)

- When the manual range is set, the accuracy is specified in 1% or more of the range.
- The accuracy is specified for series resistance of 5Ω or less.
- Maximum count for each range: 1100 (excluding 100.0 mF)

10 Temperature (type K thermocouple)

Range	Accuracy ^{*1}
-40.0 to 800.0°C	±0.5% rdg. ±3°C
-40.0 to 1472.0°F ²	±0.5% rdg. ±5.4°F

*1: In an environment where the temperature of the instrument is ±1°C and stable, the accuracy is specified.

*2: Using the power-on option setting, °F display is activated.
Fahrenheit °F = (9/5) × Celsius °C + 32

- The optional type K thermocouple are used.
- The accuracy does not include the error of the type K thermocouple.
- Standard contact temperature compensation stability time
When the instrument environmental temperature fluctuates ±5°C or more:
120 minutes
After current measurement: 30 minutes

11 DC (DCμA, DCmA, DCA)

	Range	Accuracy	Shunt	Fuse resistance
DCμA	600.00 μA	±0.05% rdg. ±5 dgt. ^{*1}	101Ω	Approx. 1.2 Ω
	6000.0 μA	±0.05% rdg. ±5 dgt.	101Ω	
DCmA	60.000 mA	±0.05% rdg. ±5 dgt. ^{*1}	1Ω	
	600.00 mA	±0.15% rdg. ±5 dgt.	1Ω	
DCA (DT4282)	6.0000 A	±0.2% rdg. ±5 dgt. ^{*1}	10mΩ	0.1 Ω or less
	10.000 A	±0.2% rdg. ±5 dgt.	10mΩ	

*1: Accuracy rule when using the slow display update rate. Add ±20 dgt. when using the normal rate.

12 AC (AC μ A, ACmA, ACA)

	Range [A]	Accuracy ^{*1}				
		20 to below 45 [Hz]	45 to 65 [Hz]	Over 65 to 1 k [Hz]	Over 1 k to 10 k [Hz]	Over 10 k to 20 k [Hz]
AC μ A	600.00 μ	$\pm 1.0\%$ rdg. ± 20 dgt.	$\pm 0.6\%$ rdg. ± 20 dgt.	$\pm 0.6\%$ rdg. ± 20 dgt.	$\pm 2\%$ rdg. ± 20 dgt.	$\pm 4\%$ rdg. ± 20 dgt.
	6000.0 μ	$\pm 1.0\%$ rdg. ± 5 dgt.	$\pm 0.6\%$ rdg. ± 5 dgt.	$\pm 0.6\%$ rdg. ± 5 dgt.	$\pm 2\%$ rdg. ± 5 dgt.	$\pm 4\%$ rdg. ± 5 dgt.
ACmA	60.000 m	$\pm 1.0\%$ rdg. ± 20 dgt.	$\pm 0.6\%$ rdg. ± 20 dgt.	$\pm 0.6\%$ rdg. ± 20 dgt.	$\pm 1\%$ rdg. ± 20 dgt.	$\pm 2\%$ rdg. ± 20 dgt.
	600.00 m	$\pm 1.0\%$ rdg. ± 5 dgt.	$\pm 0.6\%$ rdg. ± 5 dgt.	$\pm 0.6\%$ rdg. ± 5 dgt.	$\pm 1.5\%$ rdg. ± 10 dgt. ^{*2}	Not specified
ACA ^{*3}	6.0000	Not specified	$\pm 0.8\%$ rdg. ± 20 dgt.	$\pm 0.8\%$ rdg. ± 20 dgt.	Not specified	Not specified
	10.000 ^{*4}	Not specified	$\pm 0.8\%$ rdg. ± 5 dgt.	$\pm 0.8\%$ rdg. ± 5 dgt.	Not specified	Not specified

	Range	Shunt	Fuse resistance
AC μ A	600.00 μ A	101 Ω	Approx. 1.2 Ω
	6.0000 mA	101 Ω	
ACmA	60.000 mA	1 Ω	
	600.00 mA	1 Ω	
ACA ^{*3}	6.0000 A	10 m Ω	Approx. 0.1 Ω
	10.000 A	10 m Ω	

*1: The accuracy is specified in 5% or more of the range. (Less than 5% of each range is outside of the guaranteed accuracy.)

*2: For more than 300 mA, the accuracy is specified in 5 kHz or less.

*3: Only the DT4282

*4: The accuracy is specified in 2 A or more.

Accuracy Table

Crest factor	3 or less (Note that it applies to 1/2 of the range.)
Accuracy guarantee range for frequency	20 Hz to 20 kHz (A measured value outside of the accuracy guarantee range for frequency is also displayed.)

13 AC clamp (DT4281)

Range	Accuracy (only the instrument) The accuracy is specified in 15% or more of the range. (Less than 15% of each range is outside of the guaranteed accuracy.)		Conversion rate (A/mV)
	40 to 65 [Hz]	Over 65 to 1 k [Hz]	
10.00 A	±0.6% rdg. ±2 dgt.	±0.9% rdg. ±2 dgt.	0.05
20.00 A	±0.6% rdg. ±4 dgt.	±0.9% rdg. ±4 dgt.	0.10
50.00 A	±0.6% rdg. ±10 dgt.	±0.9% rdg. ±10 dgt.	0.25
100.0 A	±0.6% rdg. ±2 dgt.	±0.9% rdg. ±2 dgt.	0.5
200.0 A	±0.6% rdg. ±4 dgt.	±0.9% rdg. ±4 dgt.	1.0
500.0 A	±0.6% rdg. ±10 dgt.	±0.9% rdg. ±10 dgt.	2.5
1000 A	±0.6% rdg. ±2 dgt.	±0.9% rdg. ±2 dgt.	5

- The optional 9010-50, 9018-50, or 9132-50 Clamp on Probe is used.
- For accuracy in combination with the clamp, add the accuracy of the clamp-on probe.

Input impedance	1 MΩ ±4%, 100 pF or less
Crest factor	3 or less
Accuracy guarantee range for frequency	40 Hz to 1 kHz (A measured value outside of the accuracy guarantee range for frequency is also displayed.)

14 Frequency (Hz)

(In the case of ACV, DC+ACV, AC μ A, ACmA, or ACA)

Range	Accuracy
99.999 Hz	$\pm 0.005\%$ rdg. ± 3 dgt.
999.99 Hz	$\pm 0.005\%$ rdg. ± 3 dgt.
9.9999 kHz	$\pm 0.005\%$ rdg. ± 3 dgt.
99.999 kHz	$\pm 0.005\%$ rdg. ± 3 dgt. *1
500.00 kHz	$\pm 0.005\%$ rdg. ± 3 dgt. *1

- *1: Measurement range where the accuracy is specified in the range of 99.999 kHz/500.00 kHz
 Up to 200 kHz for ACV or AC μ A
 Up to 50 kHz for DC+ACV
 Up to 100 kHz for the range from 60.000 mV AC to 600.00 mV AC
 Up to 30 kHz for ACmA or ACA

Measurement range	0.5 Hz or more ([-----] appears for less than 0.5 Hz.)
Pulse width	1 μ s or more (duty ratio: 50%)

- With the filter ON, the accuracy is specified in 100 Hz or less.
- During DC+ACV measurement, it is in accordance with the attenuator range where the input component is large.

Minimum sensitivity voltage (During DC+ACV measurement, it indicates an RMS of the AC component.)

Range [Hz]	AC voltage range (sine wave)					
	60.000 mV	600.00 mV	6.0000 V	60.000 V	600.00 V	1000.0 V
99.999 ^{*2,*3}	6.000 mV	60.00 mV	0.6000 V	6.000 V	60.00 V	60.0 V
999.99	6.000 mV	60.00mV	0.6000 V	6.000 V	60.00 V	60.0 V
9.9999 k	6.000 mV	60.00 mV	0.6000 V	6.000 V	60.00 V	60.0 V
99.999 k	6.000 mV	60.00 mV	0.6000 V	6.000 V	Not specified	Not specified
500.00 k	20.000 mV	100.00 mV	1.0000 V	Not specified	Not specified	Not specified

The maximum input is within each range. (The 1000.0 V range depends on the ACV accuracy table)

*2: The minimum sensitivity voltage which is less than 5 Hz is tripled.

*3: With the filter ON, the minimum sensitivity voltage is multiplied by 0.7.

Minimum sensitivity current

Range [Hz]	AC range (sine wave)					
	600.00 μ A	6000.0 μ A	60.000 mA	600.00 mA	6.0000 A	10.000 A
99.999 ^{*4}	60.00 μ A	600.0 μ A	6.000 mA	60.00 mA	0.6000 A	4.000 A
999.99	60.00 μ A	600.0 μ A	6.000 mA	60.00 mA	0.6000 A	4.000 A
9.9999 k	60.00 μ A	600.0 μ A	6.000 mA	60.00 mA	0.6000 A	4.000 A
99.999 k	60.00 μ A	600.0 μ A	6.000 mA ^{*6}	60.00 mA ^{*6}	Not specified	Not specified
500.00 k	100.00 μ A ^{*5}	1000.0 μ A ^{*5}	Not specified	Not specified	Not specified	Not specified

The maximum input is within each range.

*4: The minimum sensitivity current which is less than 5 Hz is tripled.

*5: Specified in 200 kHz or less.

*6: Specified in 30 kHz or less.

15 Decibel conversion measurement

Function	Range	Standard	Standard impedance R
dBm	600.00 dBm	$W_{\text{ref}} = 1 \text{ m [W]}$	4/8/16/32/50/75/93/110/125/135/ 150/200/250/300/500/600 (default)/800/900 /1000/1200 Ω
dBV	60.00 dBV	$V_{\text{ref}} = 1 \text{ [V]}$	None

Conversion formula (as measured value V (V))

$$\text{dBm} = 10 \log_{10} \left(\frac{V^2}{\frac{R}{W_{\text{ref}}}} \right) = 10 \log_{10} \left(\frac{V^2 \times 1,000}{R} \right)$$

$$\text{dBV} = 20 \log_{10} \left(\frac{V}{V_{\text{ref}}} \right) = 20 \log_{10} V$$

Accuracy: dBm (when standard impedance is 600 Ω)

Measurement Range [dBm]	20 to below 45 [Hz]	45 to 65 [Hz]	Over 65 to 1 k [Hz]	Over 1 k to 10 k [Hz]	Over 10 k to 20 k [Hz]	Over 20 k to 100 k [Hz]
-48 to below -21	$\pm 0.8 \text{ dBm}$	$\pm 0.5 \text{ dBm}$	$\pm 0.5 \text{ dBm}$	$\pm 0.5 \text{ dBm}$	$\pm 0.6 \text{ dBm}$	$\pm 3.0 \text{ dBm}$
-21 to below -1	$\pm 0.3 \text{ dBm}$	$\pm 0.2 \text{ dBm}$	$\pm 0.2 \text{ dBm}$	$\pm 0.2 \text{ dBm}$	$\pm 0.3 \text{ dBm}$	$\pm 1.0 \text{ dBm}$
-1 to below 17	$\pm 0.3 \text{ dBm}$	$\pm 0.2 \text{ dBm}$	$\pm 0.2 \text{ dBm}$	$\pm 0.2 \text{ dBm}$	$\pm 0.2 \text{ dBm}$	$\pm 0.5 \text{ dBm}$
17 to below 37	Not specified	$\pm 0.2 \text{ dBm}$	$\pm 0.2 \text{ dBm}$	$\pm 0.2 \text{ dBm}$	$\pm 0.2 \text{ dBm}$	$\pm 0.5 \text{ dBm}$
37 to below 57	Not specified	$\pm 0.2 \text{ dBm}$	$\pm 0.2 \text{ dBm}$	$\pm 0.2 \text{ dBm}$	Not specified	Not specified
57 to 62	Not specified	$\pm 0.2 \text{ dBm}$	$\pm 0.2 \text{ dBm}$	$\pm 0.2 \text{ dBm}$	Not specified	Not specified

Accuracy: dBV

Measurement Range [dBV]	20 to below 45 [Hz]	45 to 65 [Hz]	Over 65 to 1 k [Hz]	Over 1 k to 10 k [Hz]	Over 10 k to 20 k [Hz]	Over 20 k to 100 k [Hz]
-50 to below -24	±0.8 dBV	±0.5 dBV	±0.5 dBV	±0.5 dBV	±0.6 dBV	±3.0 dBV
-24 to below -4	±0.3 dBV	±0.2 dBV	±0.2 dBV	±0.2 dBV	±0.3 dBV	±1.0 dBV
-4 to below 15	±0.3 dBV	±0.2 dBV	±0.2 dBV	±0.2 dBV	±0.2 dBV	±0.5 dBV
15 to below 35	Not specified	±0.2 dBV	±0.2 dBV	±0.2 dBV	±0.2 dBV	±0.5 dBV
35 to below 55	Not specified	±0.2 dBV	±0.2 dBV	±0.2 dBV	Not specified	Not specified
55 to 60	Not specified	±0.2 dBV	±0.2 dBV	±0.2 dBV	Not specified	Not specified

16 4-20 mA% conversion measurement

Range	Conversion formula	Accuracy
4-20 mA 350.00%	$\frac{\text{Measured value [mA]} - 4 \text{ [mA]}}{16 \text{ [mA]}} \times 100$	±0.1%rdg. ±20 dgt.
0-20 mA 300.00%	$\frac{\text{Measured value [mA]}}{20 \text{ [mA]}} \times 100$	±0.1%rdg. ±20 dgt.

60.000 mA DC range fixed

5.3 General Specifications

Product warranty duration	3 years
Accuracy guarantee duration	1 year
Operating temperature range	-15°C to 55°C (5F° to 131°F)
Operating humidity range	Up to 40°C (104°F): at 80% RH or less (non-condensing) 40°C to 45°C (104°F to 113°F): at 60% RH or less (non-condensing) 45°C to 55°C (113°F to 131°F): at 50% RH or less (non-condensing)
Storage temperature and humidity range	-30°C to 60°C (-22°F to 140°F), at 80% RH or less (non-condensing)
Operating environment	Indoors, pollution degree 2, altitude up to 2000 m (6562 ft.)
Drop-proof functionality	1 m on concrete

Power supply

Batteries	AA size LR6 Alkaline battery or AA size R6 Manganese battery x 4
Rated power supply voltage	1.5 V DC x 4
Maximum rated power supply voltage	6.8 V
Maximum rated power	0.5 VA (max) supply voltage 6.0 V, Continuity measurement, Input short circuit, Backlight on
Rated power	0.2 VA (typ) supply voltage 6.0 V, DCV measurement, Input short circuit, Backlight off
Power during OFF/APS	0.1 mVA (max) supply voltage 6.0 V

Continuous operating time

(Representative value: DCV function)

(Using new battery)

AA size battery	Backlight	
	off	on
Alkaline	Approx. 100 hours	Approx. 30 hours
Manganese	Approx. 30 hours	Approx. 10 hours

Withstand voltage

Between all measurement terminals and case: 8.54 kV AC (sine wave, 50 Hz/60 Hz, 60 seconds)

Maximum rated voltage between terminals

Between the V and COM terminals: 1000 V DC/AC or $2 \times 10^7 \text{ V} \cdot \text{Hz}$ (whichever is the lower value.)

Maximum rated current between terminals

Between the $\mu\text{A}/\text{mA}$ and COM terminals: 600 mA DC/600 mA AC
Between the A and COM terminals: 10 A DC/10 A AC (continuous)

Maximum rated voltage between measurement terminals and ground

1000 V (Measurement category III)
600 V (Measurement category IV)
Anticipated transient overvoltage: 8000 V

Dimensions	Approx. 93W × 197H × 53D mm (3.66"W × 7.76"H × 2.09"D) (excluding the projection)																												
Weight	Approx. 650 g (22.9 oz.) (including batteries)																												
Standards	<ul style="list-style-type: none"> • Safety: EN 61010 • EMC: EN 61326 • Dustproof and waterproof: IP40 (EN 60529) 																												
<div style="border: 2px solid blue; padding: 10px; background-color: #e0f0ff;"> <p>IMPORTANT</p> <p>To avoid any failure, do not allow the instrument to get wet. If the instrument gets wet, have your authorized Hioki distributor or reseller inspect or repair it, if necessary.</p> </div>																													
Accessories	See "Verifying Package Contents" (p. 2).																												
Replacement parts	<ul style="list-style-type: none"> • μA/mA terminal fuse (DT4281, DT4282) <table style="margin-left: 20px;"> <tr> <td>Manufacturer</td> <td>HOLLYLAND</td> </tr> <tr> <td>Rating</td> <td>630 mA/1000 V</td> </tr> <tr> <td>Breaking characteristics</td> <td>Fast-blow type</td> </tr> <tr> <td>Breaking capacity</td> <td>50 kA AC/30 kA DC</td> </tr> <tr> <td>Size</td> <td>ϕ10.3 mm × 38 mm</td> </tr> <tr> <td>Resistance</td> <td>Approx. 1.2Ω</td> </tr> <tr> <td>Printed color</td> <td>Blue</td> </tr> </table> • A terminal fuse (DT4282 only) <table style="margin-left: 20px;"> <tr> <td>Manufacturer</td> <td>HOLLYLAND</td> </tr> <tr> <td>Rating</td> <td>11 A/1000 V</td> </tr> <tr> <td>Breaking characteristics</td> <td>Fast-blow type</td> </tr> <tr> <td>Breaking capacity</td> <td>50 kA AC/30 kA DC</td> </tr> <tr> <td>Size</td> <td>ϕ10.3 mm × 38 mm</td> </tr> <tr> <td>Resistance</td> <td>0.1Ω or less</td> </tr> <tr> <td>Printed color</td> <td>Red</td> </tr> </table> 	Manufacturer	HOLLYLAND	Rating	630 mA/1000 V	Breaking characteristics	Fast-blow type	Breaking capacity	50 kA AC/30 kA DC	Size	ϕ 10.3 mm × 38 mm	Resistance	Approx. 1.2 Ω	Printed color	Blue	Manufacturer	HOLLYLAND	Rating	11 A/1000 V	Breaking characteristics	Fast-blow type	Breaking capacity	50 kA AC/30 kA DC	Size	ϕ 10.3 mm × 38 mm	Resistance	0.1 Ω or less	Printed color	Red
Manufacturer	HOLLYLAND																												
Rating	630 mA/1000 V																												
Breaking characteristics	Fast-blow type																												
Breaking capacity	50 kA AC/30 kA DC																												
Size	ϕ 10.3 mm × 38 mm																												
Resistance	Approx. 1.2 Ω																												
Printed color	Blue																												
Manufacturer	HOLLYLAND																												
Rating	11 A/1000 V																												
Breaking characteristics	Fast-blow type																												
Breaking capacity	50 kA AC/30 kA DC																												
Size	ϕ 10.3 mm × 38 mm																												
Resistance	0.1 Ω or less																												
Printed color	Red																												
Options	See "Options (sold separately)" (p. 2).																												

6.1 Repair, Inspection, and Cleaning

DANGER



Customers are not allowed to modify, disassemble, or repair the instrument.

Doing so may cause fire, electric shock, or injury.

Calibrations

IMPORTANT

Periodic calibration is necessary in order to ensure that the instrument provides correct measurement results of the specified accuracy.

The calibration frequency varies depending on the status of the instrument or installation environment. We recommend that the calibration frequency is determined in accordance with the status of the instrument or installation environment and that you request that calibration be performed periodically.

Replacement parts and longevity

The longevity of the instrument varies depending on the usage environment and frequency.

Note that operation within the following period of time is not guaranteed. When replacing the part, contact your authorized Hioki distributor or reseller.

Parts	Longevity
Backlight	Approx. 50000 hours

Cleaning

- To clean the instrument, wipe it gently with a soft cloth moistened with water or mild detergent.
- Wipe the display gently with a soft, dry cloth.

IMPORTANT

Never use solvents such as benzene, alcohol, acetone, ether, ketones, thinners or gasoline, as they can deform and discolor the case.

Disposal

Handle and dispose of the instrument in accordance with local regulations.

6.2 Troubleshooting

- When a malfunction of the instrument is suspected, check the information in “Before sending the instrument for repair” and then, if necessary, contact your authorized Hioki distributor or reseller.
- When sending the instrument for repair, remove the batteries and pack it carefully to prevent damage during transportation. Include cushioning material so the instrument cannot move within the package. Be sure to include details of the problem. Hioki cannot be responsible for damage that occurs during transportation.

Before sending the instrument for repair

Symptom	Check and/or remedy
Nothing appears in the display. Or the display disappears after a short time.	Check that the batteries are not exhausted. Replace with new batteries. (p. 26)
	Check that the auto power save function has not been activated. Check the setting of the auto power save function. (p. 76)
A numerical value appears when nothing is connected.	When the measurement terminal is open during DC voltage (DCV) measurement or AC voltage (ACV) measurement in the 60 mV range or 600 mV, a random value is displayed. This does not indicate a malfunction of the instrument. When the probe is connected to the measurement target, a normal numerical value is displayed. A high-input impedance voltmeter is used in the instrument for highly sensitive measurement. Consequently, external noise, such as inductive noise, appears as a numerical value.

Symptom	Check and/or remedy
<p>(Current measurement) The measured value does not appear.</p>	<p>Check that the fuse is not blown. Replace with a new fuse specified by our company. (p. 112)</p>
	<p>Check that the fuse holder is not deformed. When removing the fuse, the holder is deformed if excessive force is applied. Pinch it with needle-nose pliers and restore the shape of the fuse holder.</p>
	<p>Check that the test lead is not broken. Perform the continuity check to confirm the continuity of the test leads. (p. 38) If the test lead is broken, replace the lead.</p>
<p>(Except the current measurement) The measured value does not appear. Even after the connection or measurement, 0 (zero) still appears.</p>	<ul style="list-style-type: none"> • Check that the test leads have been inserted at the ends. • Check that the measurement method is correct. • Check that the fuse is not blown. (p. 39) <p>If no problems have been found, the circuit may be malfunctioning. Send the instrument for repair.</p>
<p>Even after short circuit of the probe, the measured value does not appear. Zero adjustment is impossible.</p>	<p>The fuse may be blown. Check method: "3 Check that the fuse is not broken." (p. 39) If the fuse is blown, replace with the specified fuse. (p. 112)</p>

Symptom	Check and/or remedy
<p>The display does not stabilize and the value fluctuates; it is difficult to read the value.</p>	<p>The display does not stabilize due to the influence of noise and/or input signals. Set the display update slower (press SLOW for 1 second) so that the display fluctuation can be eliminated. (p. 65)</p> <p>Less than 5% of each range is outside of the guaranteed accuracy at AC voltage (V AC, mV AC), DC+ACV measurement, and AC (ACμA, ACmA, ACA). Less than 15% of each range is outside of the guaranteed accuracy at AC clamp measurement. The measured value does not stabilize if the measurement signal is small.</p>
<p>[----] appears in the display.</p>	<p>[----] appears when the rotary switch position is not confirmed. Set the rotary switch to the proper position.</p>
<p>The measured value of the frequency does not stabilize.</p>	<p>The display does not stabilize due to the influence of noise and/or input signals.</p>
<p>The range cannot be changed.</p>	<p>The measurement range cannot be changed when [REL] is lit. To change the range, press REL for at least 1 second to reset the REL function.</p>
<p>Turning on the power brings up the error display. When nothing is connected, the error display appears.</p>	<p>Reset the instrument. (p. 82) If the same symptom still occurs even after resetting the instrument, send the instrument for repair.</p>

Other inquiries

Question	Solution
Would like to perform zero adjustment.	Using the relative value display function, zero adjustment can be performed. (p. 70)
Would like to replace the fuse. Would like to know how to obtain the fuse.	See “6.4 Replacing Fuses” (p.112). These are available at authorized Hioki distributors or resellers.
Can rechargeable batteries be used?	Rechargeable batteries cannot be used. Use LR6 Alkaline batteries or R6 Manganese batteries.
Would like to control multiple instruments with 1 PC.	To communicate with the instrument, the optional DT4900-01 Communication Package is required. It is possible to control multiple instruments via USB ports.
The instrument cannot communicate with the PC.	<ul style="list-style-type: none"> • Is the communication setting between the instrument and the PC correct? • Are the baud rate and parity check set correctly? (p. 78) • Is the USB cable connected correctly? (p. 78) • Are the light receiving and emitting parts clean?
Would like to know commands. Would like to perform communication using own software.	To communicate with the instrument, the optional DT4900-01 Communication Package is required. For details, see the DT4280 series Remote Operation Manual in the Communication Package. (p.78)

6.3 Error Display

Error display	Description	Solution
Err 001	ROM error Program	When the error appears in the display, it is necessary to solve by the actions below. <ul style="list-style-type: none"> • Replace with new batteries. (p.26) • Reset the instrument. (p.82) If the same symptom still occurs, it is necessary to repair the instrument.
Err 002	ROM error Adjustment data	
Err 004	EEPROM error Memory data	
Err 005	ADC error Hardware malfunction	

For other warning displays, refer to “1.4 Alarm Display and Battery Indicator” (p. 23).

6.4 Replacing Fuses

If a fuse is blown, replace it with a new one as follows.

For details on how to check that the fuse is blown, see “3 Check that the fuse is not broken.” (p. 39).

WARNING



Replace the fuse only with one of the specified type, characteristics, rated current, and rated voltage.

Do not use fuses other than those specified (especially, do not use a fuse with higher-rated current) or do not short circuit and use the fuse holder. Doing so may damage the instrument and result in personal injury.

Specified fuses

Manufacturer: HOLLYLAND

Breaking characteristic: Fast-blow type

Breaking capacity: 50 kAAC/30 kADC

Size: ϕ 10.3 mm × 38 mm

Fuse Set		Rating	Resistance	the number of fuse
Z5053	For A terminal (DT4282)	11 A/ 1000 V	0.1 Ω or less	2 pcs. set
Z5054	For μ A/mA terminal (DT4281, DT4282)	630 mA/1000 V	Approx. 1.2 Ω	2 pcs. set

The fuse set can be purchased via authorized Hioki distributors or resellers.

When removing the fuse, do not apply excessive force on the fuse holder. If the fuse holder is deformed, the connection becomes poor and the instrument cannot measure the current.

⚠ CAUTION



When replacing the fuse, do not allow foreign matter to enter the instrument. It may cause a malfunction.

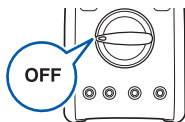

- 1** Remove the test leads from the instrument.
- 2** Set the rotary switch to OFF.

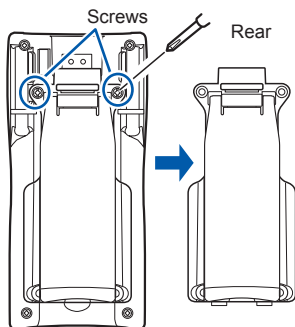

- 3** Using a Phillips screwdriver, remove the screws (2 locations) from the battery cover.
- 4** Remove the battery cover.

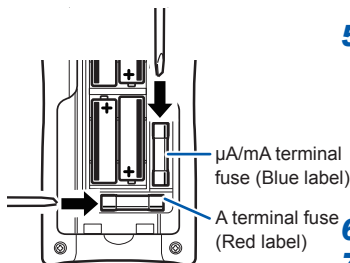

- 5** Insert a slotted screwdriver or a similar tool (from the direction of the arrow in the left figure), and remove the fuse.
- 6** Attach a new fuse.
- 7** Reattach the battery cover.
- 8** Secure the cover with the screws.

Appendix

Appx. 1 RMS and Average

Difference between the RMS and Average

When converting AC to RMS, 2 methods are available, “True RMS method (True RMS indication)” and “Average method (Average rectifying RMS indication)”.

In the case of the sine wave where no skew is included, the same values are indicated in both methods. However, if the waveform is skewed, a difference occurs between the 2 methods.

The true RMS method is applied to this instrument.

The true RMS method determines RMS values of AC signals, including harmonic components within the accuracy guarantee frequency range, and display them.

In the average method, the input waveform is handled as a sine wave where no skew is included (only single frequency). The average of the AC signal is obtained, converted to the RMS, and then displayed. If the waveform is skewed, a greater measurement error occurs.

Measurement example	True RMS	Average rectifying
100 V sine wave	100 V	100 V
100 V square wave	100 V	111 V

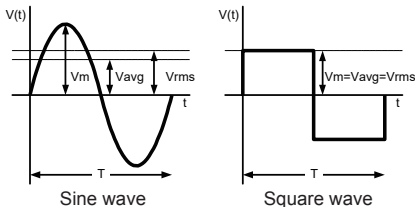

V_m : Maximum value, V_{avg} : Average value, V_{rms} : RMS, T : Time period

Appx. 2 Operation Example

Checking the noise of the DC voltage

Measure the AC component voltage, DC component voltage, and peak value.

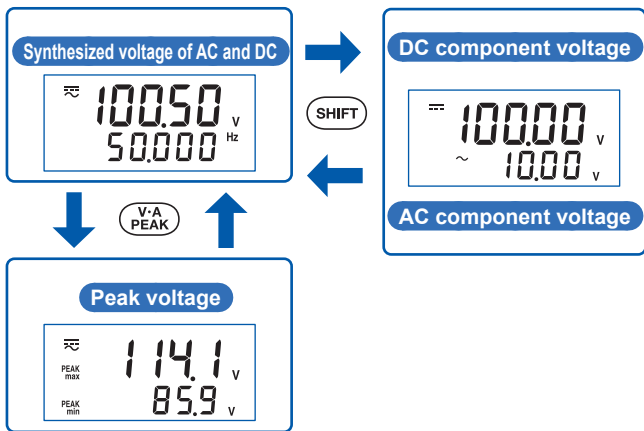
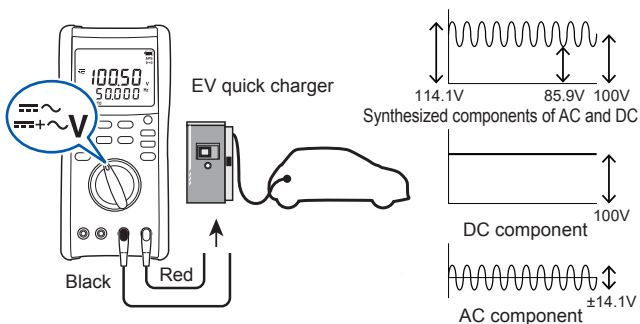

Appx. 3 Dedicated Software (DMM Communicator)

The PC application (DMM Communicator) can be used to send measurement data from the instrument to a computer or to configure instrument settings from a computer.

The DT4900-01 Communication Package (USB) dedicated communications adapter is required in order to connect the instrument to a computer.



Specifications

- Display, record, and graph measurement data from the instrument
- Configure instrument settings such as the range
- Display a connection screen based on the instrument's measurement function
- Save recorded measurement data as a CSV-format text file
- Paste measurement data into Excel
- Load DMM instrument memory data

Excel is a trademark of the Microsoft group of companies.

Warranty Certificate

HIOKI

Model	Serial number	Warranty period Three (3) years from date of purchase (___ / ___)
-------	---------------	--

Customer name: _____

Customer address: _____

Important

- Please retain this warranty certificate, Duplicates cannot be reissued.
- Complete the certificate with the model number, serial number, and date of purchase, along with your name and address. The personal information you provide on this form will **only** be used to provide repair service and information about Hioki products and services.

This document certifies that the product has been inspected and verified to conform to Hioki's standards. Please contact the place of purchase in the event of a malfunction and provide this document, in which case Hioki will repair or replace the product subject to the warranty terms described below.

Warranty terms

- The product is guaranteed to operate properly during the warranty period (three [3] years from the date of purchase). If the date of purchase is unknown, the warranty period is defined as three (3) years from the date (month and year) of manufacture (as indicated by the first four digits of the serial number in YYMM format).
- If the product came with an AC adapter, the adapter is warranted for one (1) year from the date of purchase.
- The accuracy of measured values and other data generated by the product is guaranteed as described in the product specifications.
- In the event that the product or AC adapter malfunctions during its respective warranty period due to a defect of workmanship or materials, Hioki will repair or replace the product or AC adapter free of charge.
- The following malfunctions and issues are not covered by the warranty and as such are not subject to free repair or replacement:
 - 1. Malfunctions or damage of consumables, parts with a defined service life, etc.
 - 2. Malfunctions or damage of connectors, cables, etc.
 - 3. Malfunctions or damage caused by shipment, dropping, relocation, etc., after purchase of the product
 - 4. Malfunctions or damage caused by inappropriate handling that violates information found in the instruction manual or on precautionary labeling on the product itself
 - 5. Malfunctions or damage caused by a failure to perform maintenance or inspections as required by law or recommended in the instruction manual
 - 6. Malfunctions or damage caused by fire, storms or flooding, earthquakes, lightning, power anomalies (involving voltage, frequency, etc.), war or unrest, contamination with radiation, or other acts of God
 - 7. Damage that is limited to the product's appearance (cosmetic blemishes, deformation of enclosure shape, fading of color, etc.)
 - 8. Other malfunctions or damage for which Hioki is not responsible
 - 9. After disassembly, such as opening the product, has been performed by the customer without permission by Hioki
- The warranty will be considered invalidated in the following circumstances, in which case Hioki will be unable to perform service such as repair or calibration:
 - 1. If the product has been repaired or modified by a company, entity, or individual other than Hioki
 - 2. If the product has been embedded in another piece of equipment for use in a special application (aerospace, nuclear power, medical use, vehicle control, etc.) without Hioki's having received prior notice
- If you experience a loss caused by use of the product and Hioki determines that it is responsible for the underlying issue, Hioki will provide compensation in an amount not to exceed the purchase price, with the following exceptions:
 - 1. Secondary damage arising from damage to a measured device or component that was caused by use of the product
 - 2. Damage arising from measurement results provided by the product
 - 3. Damage to a device other than the product that was sustained when connecting the device to the product (including via network connections)
- Hioki reserves the right to decline to perform repair, calibration, or other service for products for which a certain amount of time has passed since their manufacture, products whose parts have been discontinued, and products that cannot be repaired due to unforeseen circumstances.

HIOKI E. E. CORPORATION
25-10 EN-3

HIOKI

www.hioki.com/



**All regional
contact
information**

HIOKI E.E. CORPORATION

81 Koizumi, Ueda, Nagano 386-1192 Japan

2402 EN

Edited and published by HIOKI E.E. CORPORATION

Printed in Japan

- Contents subject to change without notice.
- This document contains copyrighted content.
- It is prohibited to copy, reproduce, or modify the content of this document without permission.
- Company names, product names, etc. mentioned in this document are trademarks or registered trademarks of their respective companies.

Europe only

- EU declaration of conformity can be downloaded from our website.
- Contact in Europe: HIOKI EUROPE GmbH
Helfmann-Park 2, 65760 Eschborn, Germany

hioki@hioki.eu