

Features

- 1 & 2 Pole relay range**
 40.31 - 1 Pole 10 A (3.5 mm pin pitch)
 40.51 - 1 Pole 10 A (5 mm pin pitch)
 40.52 - 2 Pole 8 A (5 mm pin pitch)

- PCB mount**
 - direct or via PCB socket
35 mm rail mount
 - via screw and screwless sockets

- DC coils (standard or sensitive) & AC coils
- Cadmium Free contact material
- 8 mm, 6 kV (1.2/50 μs) isolation, coil-contacts
- UL Listing (certain relay/socket combinations)
- Flux proof: RT II standard, (RT III option)
- 95 series sockets
- Coil EMC suppression
- Timer accessories 86 series

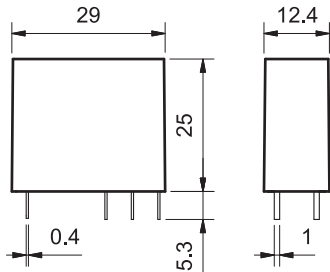

FOR UL HORSEPOWER AND PILOT DUTY RATINGS
 SEE "General technical information" page V

40.31



- 3.5 mm contact pin pitch
- 1 Pole 10 A
- PCB or 95 series sockets

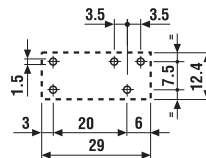
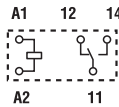

Copper side view

40.51



- 5 mm contact pin pitch
- 1 Pole 10 A
- PCB or 95 series sockets

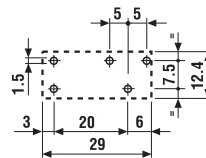
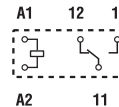

Copper side view

40.52



- 5 mm contact pin pitch
- 2 Pole 8 A
- PCB or 95 series sockets

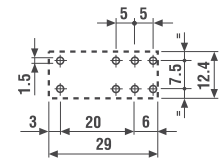
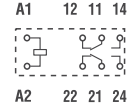

Copper side view

| Contact specification | | 40.31 | 40.51 | 40.52 |
|--|-----------------|---|--------------|--------------|
| Contact configuration | | 1 CO (SPDT) | 1 CO (SPDT) | 2 CO (DPDT) |
| Rated current/Maximum peak current | A | 10/20 | 10/20 | 8/15 |
| Rated voltage/Maximum switching voltage V AC | | 250/400 | 250/400 | 250/400 |
| Rated load AC1 | VA | 2,500 | 2,500 | 2,000 |
| Rated load AC15 (230 V AC) | VA | 500 | 500 | 400 |
| Single phase motor rating (230 V AC) | kW | 0.37 | 0.37 | 0.3 |
| Breaking capacity DC1: 30/110/220 V | A | 10/0.3/0.12 | 10/0.3/0.12 | 8/0.3/0.12 |
| Minimum switching load | mW (V/mA) | 300 (5/5) | 300 (5/5) | 300 (5/5) |
| Standard contact material | | AgNi | AgNi | AgNi |
| Coil specification | | | | |
| Nominal voltage (U _N) | V AC (50/60 Hz) | 6 - 12 - 24 - 48 - 60 - 110 - 120 - 230 - 240 | | |
| | V DC | 5 - 6 - 7 - 9 - 12 - 14 - 18 - 21 - 24 - 28 - 36 - 48 - 60 - 90 - 110 - 125 | | |
| Rated power AC/DC/sens. DC | VA (50 Hz)/W/W | 1.2/0.65/0.5 | 1.2/0.65/0.5 | 1.2/0.65/0.5 |
| Operating range | AC | (0.8...1.1)U _N | | |
| | DC/sens. DC | (0.73...1.5)U _N /(0.73...1.75)U _N | | |
| Holding voltage | AC/DC | 0.8 U _N / 0.4 U _N | | |
| Must drop-out voltage | AC/DC | 0.2 U _N / 0.1 U _N | | |
| Technical data | | | | |
| Mechanical life AC/DC | cycles | 10 · 10 ⁶ /20 · 10 ⁶ | | |
| Electrical life at rated load AC1 | cycles | 200 · 10 ³ | | |
| Operate/release time | ms | 7/3 - (12/4 sensitive) | | |
| Insulation between coil and contacts (1.2/50 μs) | kV | 6 (8 mm) | | |
| Dielectric strength between open contacts V AC | | 1,000 | | |
| Ambient temperature range | °C | -40...+85 | | |
| Environmental protection | | RT II** | | |

Approvals (according to type)



** See general technical information "Guidelines for automatic flow solder processes" page II .

Features

40.61 - 1 Pole 16 A (5 mm pin pitch)
 40.xx.6 - Bistable versions of the 40.31, 40.51, 40.52 & 40.61 relays

PCB mount

- direct or via PCB socket

35 mm rail mount

- via screw and screwless sockets

- DC coils & AC coils
- Cadmium Free option available
- 8 mm, 6 kV (1.2/50 µs) isolation, coil-contacts
- UL Listing (certain 40.61 relay/socket combinations)
- Flux proof: RT II standard, (RT III option)
- 95 series sockets
- Coil EMC suppression
- Timer accessories 86 series

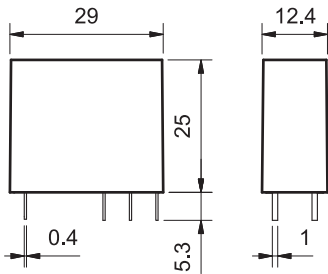

- 5 mm contact pin pitch
- 1 Pole 16 A
- PCB or 95 series sockets

- Bistable (single coil) versions of 40.31/51/52/61
- PCB or 95 series sockets

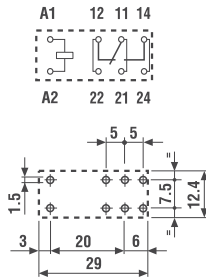

Copper side view

Bistable version (1 coil) types:

- 40.31.6...
- 40.51.6...
- 40.52.6...
- 40.61.6...

For wiring diagrams see page 8

FOR UL HORSEPOWER AND PILOT DUTY RATINGS
 SEE "General technical information" page V

| Contact specification | | |
|--|-----------------|---|
| Contact configuration | | 1 CO (SPDT) |
| Rated current/Maximum peak current | A | 16/30* |
| Rated voltage/Maximum switching voltage V AC | | 250/400 |
| Rated load AC1 | VA | 4,000 |
| Rated load AC15 (230 V AC) | VA | 750 |
| Single phase motor rating (230 V AC) | kW | 0.55 |
| Breaking capacity DC1: 30/110/220 V | A | 16/0.3/0.12 |
| Minimum switching load | mW (V/mA) | 500 (10/5) |
| Standard contact material | | AgCdO |
| Coil specification | | |
| Nominal voltage (U _N) | V AC (50/60 Hz) | 6-12-24-48-60-110-120-230-240 |
| | V DC | ***See table |
| Rated power AC/DC/sens. DC | VA (50 Hz)/W/W | 1.2/0.65/0.5 |
| Operating range | AC | (0.8...1.1)U _N |
| | DC/sens. DC | (0.73...1.5)U _N /(0.8...1.5)U _N |
| Holding voltage | AC/DC | 0.8 U _N / 0.4 U _N |
| Must drop-out voltage | AC/DC | 0.2 U _N / 0.1 U _N |
| Technical data | | |
| Mechanical life AC/DC | cycles | 10 · 10 ⁶ / 20 · 10 ⁶ |
| Electrical life at rated load AC1 | cycles | 100 · 10 ³ |
| Operate/release time | ms | 7/3 - (12/4 sensitive) |
| Insulation between coil and contacts (1.2/50 µs) | kV | 6 (8 mm) |
| Dielectric strength between open contacts V AC | | 1,000 |
| Ambient temperature range | °C | -40...+85 |
| Environmental protection | | RT II** |

See relays
 40.31
 40.51
 40.52
 40.61

* With the AgSnO₂ material the maximum peak current is 120 A - 5 ms on normally open contact.

*** Nominal voltage (U_N):
 5 - 6 - 7 - 9 - 12 - 14 - 18 - 21 - 24 - 28 - 36 - 48 - 60 - 90 - 110 - 125 V DC

Min. impulse duration
 ≥ 20 ms

Approvals (according to type)



Features

1 Pole relay range

- 40.11 - 1 Pole 10 A (Flat pack)
- 40.11-2016 - 1 Pole 16 A (Flat pack)
- 40.41 - 1 Pole 10 A (Vertical)

PCB mount

- direct or via PCB socket (40.41 version)
- DC coils
- Cadmium Free option available
- 8 mm, 6 kV (1.2/50 µs) isolation, coil-contacts
- 40.41 - NO version available

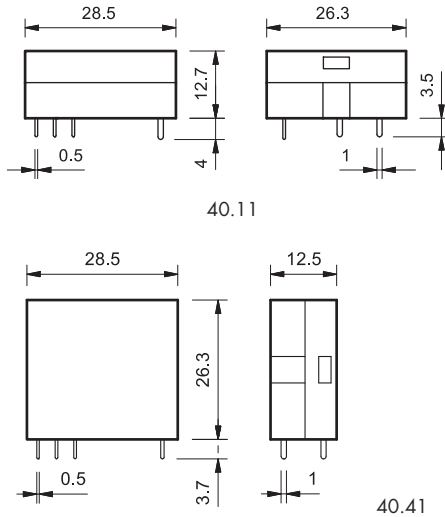

FOR UL HORSEPOWER AND PILOT DUTY RATINGS
SEE "General technical information" page V

Contact specification

| | | | |
|--|-------------|-------------|-------------|
| Contact configuration | 1 CO (SPDT) | 1 CO (SPDT) | 1 CO (SPDT) |
| Rated current/Maximum peak current A | 10/20 | 16/30 | 10/20 |
| Rated voltage/Maximum switching voltage V AC | 250/400 | 250/400 | 250/400 |
| Rated load AC1 VA | 2,500 | 4,000 | 2,500 |
| Rated load AC15 (230 V AC) VA | 500 | 750 | 500 |
| Single phase motor rating (230 V AC) kW | 0.37 | 0.55 | 0.37 |
| Breaking capacity DC1: 30/110/220 V A | 10/0.3/0.12 | 16/0.3/0.12 | 10/0.3/0.12 |
| Minimum switching load mW (V/mA) | 300 (5/5) | 500 (10/5) | 300 (5/5) |
| Standard contact material | AgCdO | AgCdO | AgCdO |

Coil specification

| | | | | |
|---|----------------------|-------------------------------|------------------------------|-------------------------------|
| Nominal voltage (U _N) | V AC (50/60 Hz) | — | — | — |
| | V DC | 6 - 12 - 24 - 48 - 60 | 6 - 12 - 24 - 48 | 6 - 12 - 24 - 48 - 60 |
| Rated power AC/DC/sens. DC VA (50 Hz)/W/W | —/—/0.5 | —/—/0.5 | —/—/0.5 | |
| Operating range | AC | — | — | — |
| | DC/sens. DC | —/(0.73...1.75)U _N | —/(0.73...1.5)U _N | —/(0.73...1.75)U _N |
| Holding voltage AC/DC | —/0.4 U _N | —/0.4 U _N | —/0.4 U _N | |
| Must drop-out voltage AC/DC | —/0.1 U _N | —/0.1 U _N | —/0.1 U _N | |

Technical data

| | | | | |
|--|--------|------------------------|------------------------|------------------------|
| Mechanical life AC/DC | cycles | —/20 · 10 ⁶ | —/20 · 10 ⁶ | —/20 · 10 ⁶ |
| Electrical life at rated load AC1 | cycles | 200 · 10 ³ | 50 · 10 ³ | 200 · 10 ³ |
| Operate/release time | ms | 12/4 | 12/4 | 12/4 |
| Insulation between coil and contacts (1.2/50 µs) | kV | 6 (8 mm) | 6 (8 mm) | 6 (8 mm) |
| Dielectric strength between open contacts V AC | | 1,000 | 1,000 | 1,000 |
| Ambient temperature range | °C | −40...+70 | −40...+70 | −40...+70 |
| Environmental protection | | RT I | RT I | RT I |

Approvals (according to type)



40.11



- 1 Pole 10 A
- Flat pack
- PCB mount

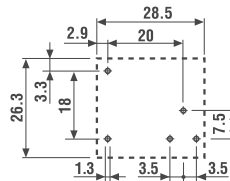
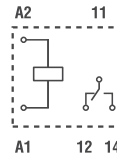

Copper side view

40.11-2016



- 1 Pole 16 A
- Flat pack
- PCB mount

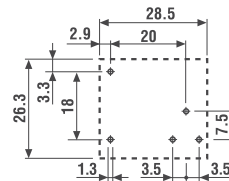
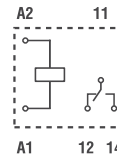

Copper side view

40.41



- 1 Pole 10 A
- Vertical
- PCB or 95 series socket

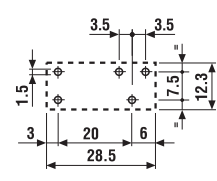
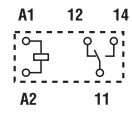

Copper side view

Ordering information

Example: 40 series PCB relay, 2 CO (DPDT), 230 V AC coil.

4

0

.

5

.

2

.

8

.

2

.

3

.

0

.

0

.

0

.

0

.

0

A
B
C
D

Series —————

Type —————

1 = PCB - 3.5 mm pinning, flat
 3 = PCB - 3.5 mm pinning
 4 = PCB - 3.5 mm pinning
 5 = PCB - 5 mm pinning
 6 = PCB - 5 mm pinning

No. of poles —————

1 = 1 pole
 for: 40.11, 10 A/16 A
 40.31, 10 A
 40.41, 10 A
 40.51, 10 A
 40.61, 16 A

2 = 2 pole
 for: 40.52, 8 A

Coil version —————

6 = AC/DC bistable
 7 = Sensitive DC
 8 = AC (50/60 Hz)
 9 = DC

Coil voltage —————

See coil specifications

A: Contact material

0 = Standard AgNi
 for 40.31/51/52,
 AgCdO for 40.61

2 = AgCdO (standard
 for 40.11/41)

4 = AgSnO₂
 5 = AgNi + Au (5 μm)

B: Contact circuit

0 = CO (nPDT)
 3 = NO (nPST)

D: Special versions

0 = Standard
 1 = Wash tight (RT III)
 3 = High temperature (+ 125 °C) wash tight

C: Options

0 = None
 16 = With rated current 16 A (for 40.11)

Selecting features and options: only combinations in the same row are possible.
 Preferred selections for best availability are shown in **bold**.

| Type | Coil version | A | B | C | D |
|--------------------|--------------|------------------|--------------|----------|------------------|
| 40.11 | sensitive DC | 2 - 4 | 0 | 0 | 0 |
| 40.11 | sensitive DC | 2 - 4 | 0 | 16 | / |
| 40.41 | sensitive DC | 0 - 2 | 0 - 3 | 0 | 0 |
| 40.31/51 | AC-sens. DC | 0 - 2 - 5 | 0 - 3 | 0 | 0 - 1 |
| 40.31/51 | DC | 0 - 2 - 5 | 0 - 3 | 0 | 0 - 1 - 3 |
| 40.52 | AC-sens. DC | 0 - 2 - 5 | 0 - 3 | 0 | 0 - 1 |
| 40.52 | DC | 0 - 2 - 5 | 0 - 3 | 0 | 0 - 1 - 3 |
| 40.61 | AC-sens. DC | 0 - 4 | 0 - 3 | 0 | 0 - 1 |
| 40.61 | DC | 0 - 4 | 0 - 3 | 0 | 0 - 1 - 3 |
| 40.31/51/ 52/61 | bistable | 0 | 0 | 0 | 0 |

Technical data

| Insulation according to EN 61810-1 | | | | | |
|--|-------------------------|---------------------|----------------------|---------------------|-------------------------|
| | | 1 pole | | 2 pole | |
| Nominal voltage of supply system | V AC | 230/400 | | 230/400 | |
| Rated insulation voltage | V AC | 250 | 400 | 250 | 400 |
| Pollution degree | | 3 | 2 | 3 | 2 |
| Insulation between coil and contact set | | | | | |
| Type of insulation | | Reinforced (8 mm) | | Reinforced (8 mm) | |
| Overvoltage category | | III | | III | |
| Rated impulse voltage | kV (1.2/50 µs) | 6 | | 6 | |
| Dielectric strength | V AC | 4,000 | | 4,000 | |
| Insulation between adjacent contacts | | | | | |
| Type of insulation | | — | | Basic | |
| Overvoltage category | | — | | II | |
| Rated impulse voltage | kV (1.2/50 µs) | — | | 2.5 | |
| Dielectric strength | V AC | — | | 2,000 | |
| Insulation between open contacts | | | | | |
| Type of disconnection | | Micro-disconnection | | Micro-disconnection | |
| Dielectric strength | V AC/kV (1.2/50 µs) | 1,000/1.5 | | 1,000/1.5 | |
| Conducted disturbance immunity | | | | | |
| Burst (5...50)ns, 5 kHz, on A1 - A2 | | EN 61000-4-4 | | level 4 (4 kV) | |
| Surge (1.2/50 µs) on A1 - A2 (differential mode) | | EN 61000-4-5 | | level 3 (2 kV) | |
| Other data | | | | | |
| Bounce time: NO/NC | ms | 2/5 | | | |
| Vibration resistance (5...55)Hz: NO/NC | g | 10/4 (1 changeover) | | 15/3 (2 changeover) | |
| Shock resistance | g | 13 | | | |
| Power lost to the environment | without contact current | W | 0.6 | | |
| | with rated current | W | 1.2 (40.11/31/41/51) | | 2 (40.61/52/40.11-2016) |
| Recommended distance between relays mounted on PCB | mm | ≥ 5 | | | |

Contact specification

F 40 - Electrical life (AC) v contact current
Types 40.31/51/61

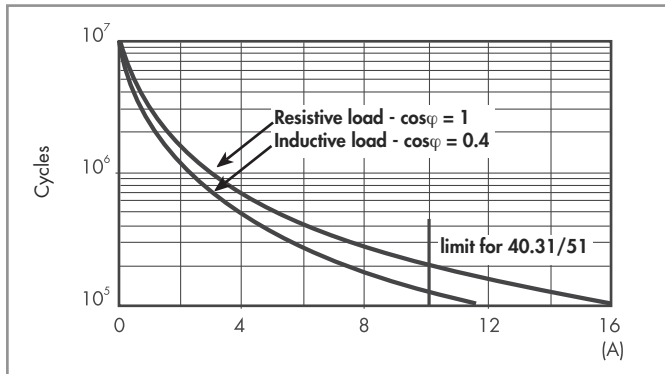

F 40 - Electrical life (AC) v contact current
Type 40.52

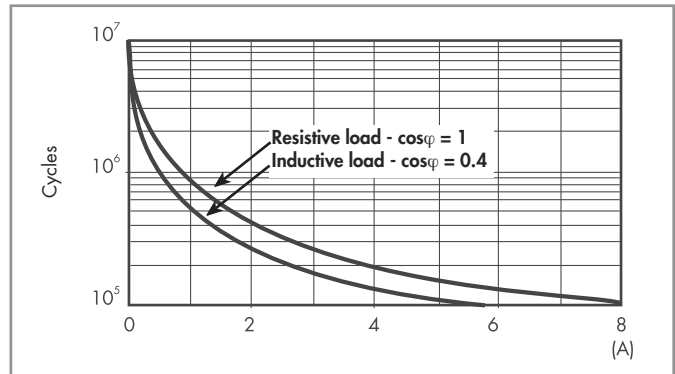

F 40 - Electrical life (AC) v contact current
Types 40.11/41

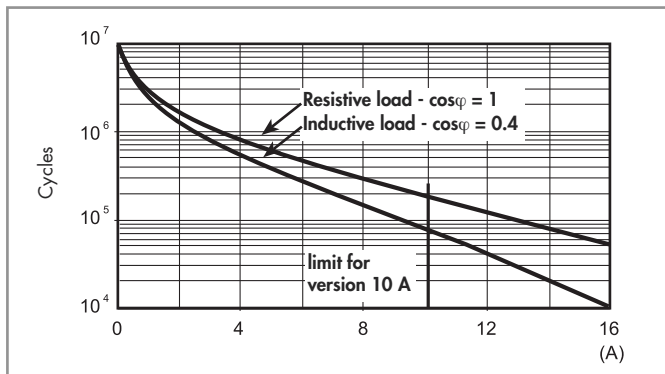

H 40 - Maximum DC1 breaking capacity

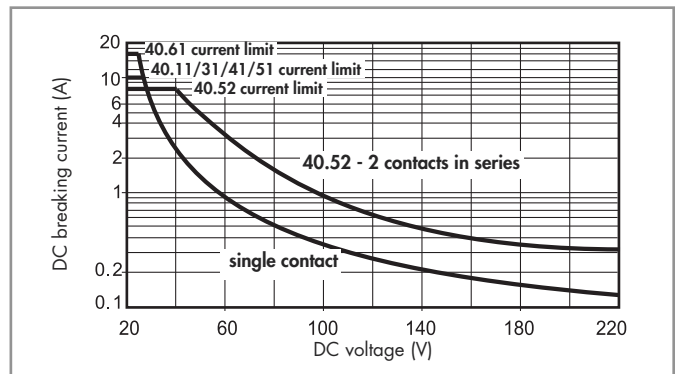

- When switching a resistive load (DC1) having voltage and current values under the curve, an electrical life of $\geq 100 \cdot 10^3$ can be expected.
- In the case of DC13 loads, the connection of a diode in parallel with the load will permit a similar electrical life as for a DC1 load.
Note: the release time for the load will be increased.

Coil specifications

DC coil data - 0.65 W standard (types 40.31/51/52/61)

| Nominal voltage U_N V | Coil code | Operating range | | Resistance R Ω | Rated coil consumption I at U_N mA |
|-------------------------------|-----------|-----------------|----------------|-----------------------------|--|
| | | U_{min} V | U_{max} V | | |
| 5 | 9.005 | 3.65 | 7.5 | 38 | 130 |
| 6 | 9.006 | 4.4 | 9 | 55 | 109 |
| 7 | 9.007 | 5.1 | 10.5 | 75 | 94 |
| 9 | 9.009 | 6.6 | 13.5 | 125 | 72 |
| 12 | 9.012 | 8.8 | 18 | 220 | 55 |
| 14 | 9.014 | 10.2 | 21 | 300 | 47 |
| 18 | 9.018 | 13.1 | 27 | 500 | 36 |
| 21 | 9.021 | 15.3 | 31.5 | 700 | 30 |
| 24 | 9.024 | 17.5 | 36 | 900 | 27 |
| 28 | 9.028 | 20.5 | 42 | 1,200 | 23 |
| 36 | 9.036 | 26.3 | 54 | 2,000 | 18 |
| 48 | 9.048 | 35 | 72 | 3,500 | 14 |
| 60 | 9.060 | 43.8 | 90 | 5,500 | 11 |
| 90 | 9.090 | 65.7 | 135 | 12,500 | 7.2 |
| 110 | 9.110 | 80.3 | 165 | 18,000 | 6.2 |
| 125 | 9.125 | 91.2 | 188 | 23,500 | 5.3 |

DC coil data - 0.5 W sensitive (types 40.31/51/52/61)

| Nominal voltage U_N V | Coil code | Operating range | | Resistance R Ω | Rated coil consumption I at U_N mA |
|-------------------------------|-----------|------------------|---------------------|-----------------------------|--|
| | | U_{min}^* V | U_{max}^{**} V | | |
| 5 | 7.005 | 3.7 | 8.8 | 50 | 100 |
| 6 | 7.006 | 4.4 | 10.5 | 75 | 80 |
| 7 | 7.007 | 5.1 | 12.2 | 100 | 70 |
| 9 | 7.009 | 6.6 | 15.8 | 160 | 56 |
| 12 | 7.012 | 8.8 | 21 | 300 | 40 |
| 14 | 7.014 | 10.2 | 24.5 | 400 | 35 |
| 18 | 7.018 | 13.2 | 31.5 | 650 | 27.7 |
| 21 | 7.021 | 15.4 | 36.9 | 900 | 23.4 |
| 24 | 7.024 | 17.5 | 42 | 1,200 | 20 |
| 28 | 7.028 | 20.5 | 49 | 1,600 | 17.5 |
| 36 | 7.036 | 26.3 | 63 | 2,600 | 13.8 |
| 48 | 7.048 | 35 | 84 | 4,800 | 10 |
| 60 | 7.060 | 43.8 | 105 | 7,200 | 8.4 |
| 90 | 7.090 | 65.7 | 157 | 16,200 | 5.6 |
| 110 | 7.110 | 80.3 | 192 | 23,500 | 4.7 |
| 125 | 7.125 | 91.2 | 219 | 32,000 | 3.9 |

* $U_{min} = 0.8 U_N$ for 40.61

** $U_{max} = 1.5 U_N$ for 40.61

DC coil data - 0.5 W sensitive (types 40.11/41)

| Nominal voltage U_N V | Coil code | Operating range | | Resistance R Ω | Rated coil consumption I at U_N mA |
|-------------------------------|-----------|-----------------|------------------|-----------------------------|--|
| | | U_{min} V | U_{max}^* V | | |
| 6 | 7.006 | 4.4 | 10.5 | 75 | 80 |
| 12 | 7.012 | 8.8 | 21 | 300 | 40 |
| 24 | 7.024 | 17.5 | 42 | 1,200 | 20 |
| 48 | 7.048 | 35 | 84 | 4,600 | 10.4 |
| 60 | 7.060 | 43.8 | 105 | 7,200 | 8.3 |

* $U_{max} = 1.5 U_N$ for 40.11-2016

AC coil data (types 40.31/51/52/61)

| Nominal voltage U_N V | Coil code | Operating range | | Resistance R Ω | Rated coil consumption I at U_N (50Hz) mA |
|-------------------------------|-----------|-----------------|----------------|-----------------------------|---|
| | | U_{min} V | U_{max} V | | |
| 6 | 8.006 | 4.8 | 6.6 | 21 | 168 |
| 12 | 8.012 | 9.6 | 13.2 | 80 | 90 |
| 24 | 8.024 | 19.2 | 26.4 | 320 | 45 |
| 48 | 8.048 | 38.4 | 52.8 | 1,350 | 21 |
| 60 | 8.060 | 48 | 66 | 2,100 | 16.8 |
| 110 | 8.110 | 88 | 121 | 6,900 | 9.4 |
| 120 | 8.120 | 96 | 132 | 9,000 | 8.4 |
| 230 | 8.230 | 184 | 253 | 28,000 | 5 |
| 240 | 8.240 | 192 | 264 | 31,500 | 4.1 |

AC/DC coil data - bistable (types 40.31/51/52/61)

| Nominal voltage U_N V | Coil code | Operating range | | Resistance R Ω | Rated coil consumption I at U_N mA | DC: Release resistance** R_{DC} Ω |
|-------------------------------|-----------|-----------------|----------------|-----------------------------|--|--|
| | | U_{min} V | U_{max} V | | | |
| 5 | 6.005 | 4 | 5.5 | 23 | 215 | 37 |
| 6 | 6.006 | 4.8 | 6.6 | 33 | 165 | 62 |
| 12 | 6.012 | 9.6 | 13.2 | 130 | 83 | 220 |
| 24 | 6.024 | 19.2 | 26.4 | 520 | 40 | 910 |
| 48 | 6.048 | 38.4 | 52.8 | 2,100 | 21 | 3,600 |
| 110 | 6.110 | 88 | 121 | 11,000 | 10 | 16,500 |

** R_{DC} = Resistance in DC, $R_{AC} = 1.3 \times R_{DC}$ 1W

Coil specifications

R 40 - DC coil operating range v ambient temperature
Standard coil

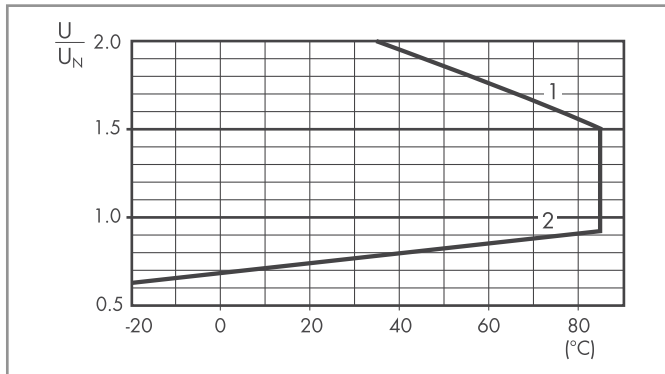

R 40 - DC coil operating range v ambient temperature
Sensitive coil, types 40.31/51/52/61

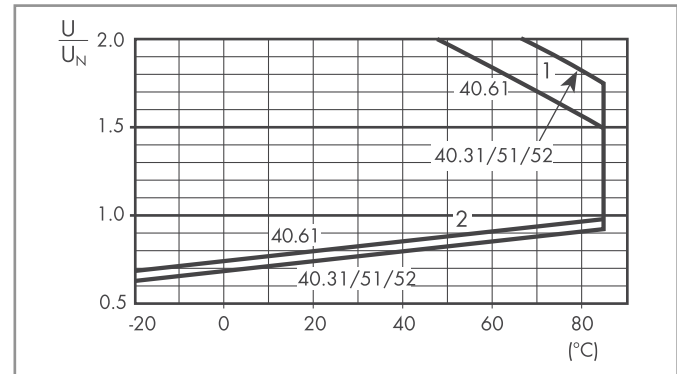

R 40 - DC coil operating range v ambient temperature
Sensitive coil, types 40.11/41

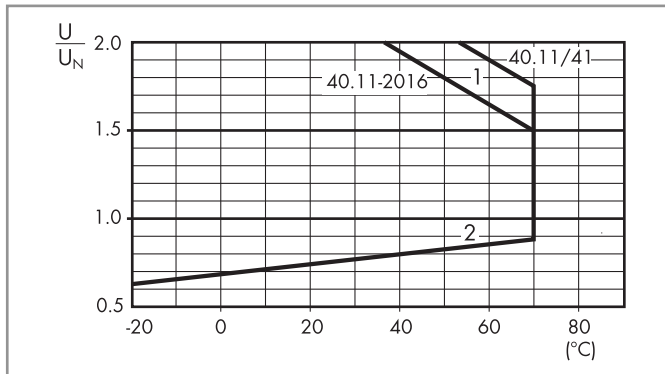

R 40 - AC coil operating range v ambient temperature

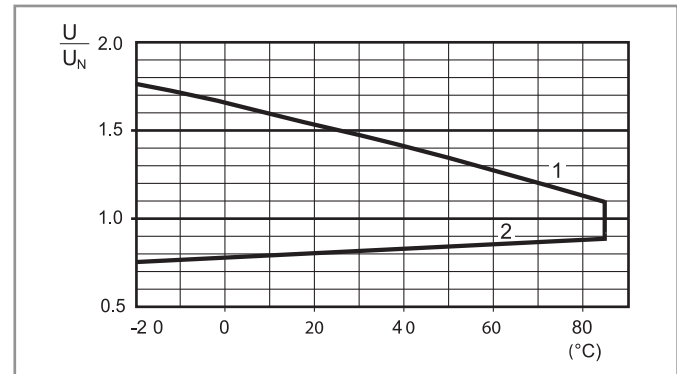

1 - Max. permitted coil voltage.
2 - Min. pick-up voltage with coil at ambient temperature.

1 - Max. permitted coil voltage.
2 - Min. pick-up voltage with coil at ambient temperature.

Wiring diagram for 40 series bistable coil version

AC Operation

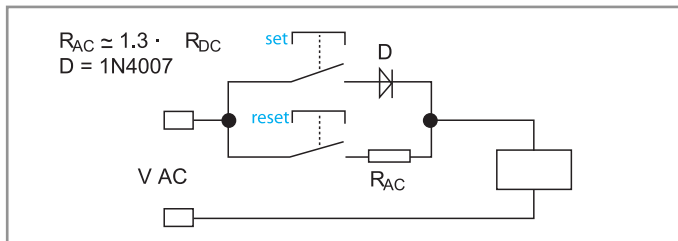

DC Operation

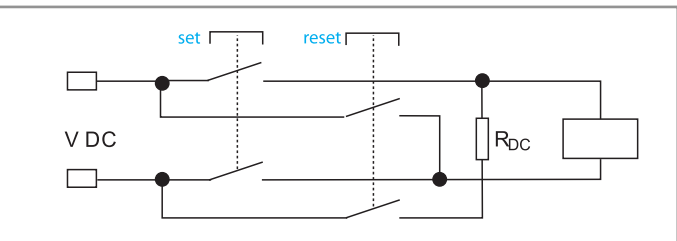

On momentary closure of the SET switch the relay is magnetised through the diode and the relay contacts transfer to the set position and remain in this position.

On momentary closure of the RESET switch the relay is demagnetised through limiting resistor (R_{AC}) and the contacts return to the reset position.

On momentary closure of the SET switch the relay is magnetised and the relay contacts transfer to the set position and remain in this position.

On momentary closure of the RESET switch the relay is demagnetised through limiting resistor (R_{DC}) and the contacts return to the reset position.

Notes: The minimum SET or RESET impulse time is 20 ms. The maximum time can be continuous. In practice, always ensure that the SET and RESET contacts cannot be operated simultaneously.



95.05
See page 10



| Module | Socket | Relay | Description | Mounting | Accessories |
|--------|--------|-------|---|---|---|
| 99.02 | 95.03 | 40.31 | Screw terminal (Box clamp) socket - Top terminals - Contacts - Bottom terminals - Coil | Panel or 35 mm rail (EN 60715) mount | - Coil indication and EMC suppression modules - Jumper link - Timer modules - Plastic retaining and release clip |
| | 95.05 | 40.51 | | | |
| | | 40.52 | | | |
| | | 40.61 | | | |



95.85.3
See page 11



| Module | Socket | Relay | Description | Mounting | Accessories |
|--------|---------|-------|--|---|--|
| 99.80 | 95.83.3 | 40.31 | Screw terminal (Box clamp) socket 95.83.3 wiring: - Top terminals - Contacts - Bottom terminals - Coil | Panel or 35 mm rail (EN 60715) mount | - Coil indication and EMC suppression modules - Jumper link - Plastic retaining and release clip |
| | 95.85.3 | 40.51 | | | |
| | | 40.52 | | | |
| | | 40.61 | | | |



95.95.3
See page 12



| Module | Socket | Relay | Description | Mounting | Accessories |
|--------|---------|-------|---|---|--|
| 99.80 | 95.93.3 | 40.31 | Screw terminal (Box clamp) socket - Top terminals - Contacts - Bottom terminals - Coil | Panel or 35 mm rail (EN 60715) mount | - Coil indication and EMC suppression modules - Jumper link - Plastic retaining and release clip |
| | 95.95.3 | 40.51 | | | |
| | | 40.52 | | | |
| | | 40.61 | | | |



95.55
See page 13



| Module | Socket | Relay | Description | Mounting | Accessories |
|--------|--------|-------|---|---|--|
| 99.02 | 95.55 | 40.51 | Screwless terminal socket - For fast cable connections - Top terminals - Contacts - Bottom terminals - Coil | Panel or 35 mm rail (EN 60715) mount | - Coil indication and EMC suppression modules - Timer modules - Plastic retaining and release clip |
| | | 40.52 | | | |
| | | 40.61 | | | |



95.55.3
See page 14



| Module | Socket | Relay | Description | Mounting | Accessories |
|--------|---------|-------|---|---|---|
| 99.80 | 95.55.3 | 40.51 | Screwless terminal socket For fast cable connections - Top terminals - Contacts - Bottom terminals - Coil | Panel or 35 mm rail (EN 60715) mount | - Coil indication and EMC suppression modules - Plastic retaining and release clip |
| | | 40.52 | | | |
| | | 40.61 | | | |



95.63
See page 15



| Module | Socket | Relay | Description | Mounting | Accessories |
|--------|--------|-------|---|---|---|
| 99.01 | 95.63 | 40.31 | Screw terminal (Box clamp) socket - Top terminals - Contacts - Bottom terminals - Coil | Panel or 35 mm rail (EN 60715) mount | - Coil indication and EMC suppression modules - Metal retaining clip |



95.65
See page 15



| Module | Socket | Relay | Description | Mounting | Accessories |
|--------|--------|-------|---|---|------------------------|
| — | 95.65 | 40.51 | Screw terminal (Box clamp) socket - Top terminals - Contacts - Bottom terminals - Coil | Panel or 35 mm rail (EN 60715) mount | - Metal retaining clip |
| | | 40.52 | | | |
| | | 40.61 | | | |



95.13.2
See page 16

| Module | Socket | Relay | Description | Mounting | Accessories |
|--------|---------|-------|-------------------|--------------|--|
| — | 95.13.2 | 40.31 | PCB socket | PCB mounting | - Metal retaining clip - Plastic retaining clip |
| | | 40.41 | | | |
| — | 95.15.2 | 40.51 | | | |
| | | 40.52 | | | |
| | | 40.61 | | | |

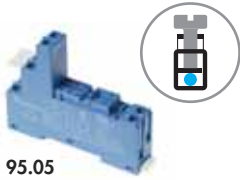

95.05

Approvals (according to type):



cRU US Certain relay/socket combinations



95.01



060.72



95.18



86.30



99.02

Approvals (according to type):



DC Modules with non-standard polarity (+A2) on request.

| Screw terminal (Box clamp) socket panel or 35 mm rail mount | 95.03 (blue) | 95.03.0 (black) | 95.05 (blue) | 95.05.0 (black) |
|--|--|-----------------|---------------------|-----------------|
| For relay type | 40.31 | | 40.51, 40.52, 40.61 | |
| Accessories | | | | |
| Metal retaining clip | | 095.71 | | |
| Plastic retaining and release clip (supplied with socket - packaging code SPA) | 095.01 | 095.01.0 | 095.01 | 095.01.0 |
| 8-way jumper link | 095.18 | 095.18.0 | 095.18 | 095.18.0 |
| Identification tag | | 095.00.4 | | |
| Modules (see table below) | | 99.02 | | |
| Timer modules (see table below) | | 86.30 | | |
| Sheet of marker tags for retaining and release clip 095.01 plastic, 72 tags, 6x12 mm | | 060.72 | | |
| Technical data | | | | |
| Rated values | 10 A - 250 V * | | | |
| Dielectric strength | 6 kV (1.2/50 µs) between coil and contacts | | | |
| Protection category | IP 20 | | | |
| Ambient temperature | °C -40...+70 | | | |
| ⊕ Screw torque | Nm | 0.5 | | |
| Wire strip length | mm | 8 | | |
| Max. wire size for 95.03 and 95.05 sockets | | solid wire | stranded wire | |
| | mm ² | 1x6 / 2x2.5 | 1x4 / 2x2.5 | |
| | AWG | 1x10 / 2x14 | 1x12 / 2x14 | |

* For currents >10 A, contact terminals must be connected in parallel (21 with 11, 24 with 14, 22 with 12). With the relay 40.51 the change-over contact will be 21-12-14.

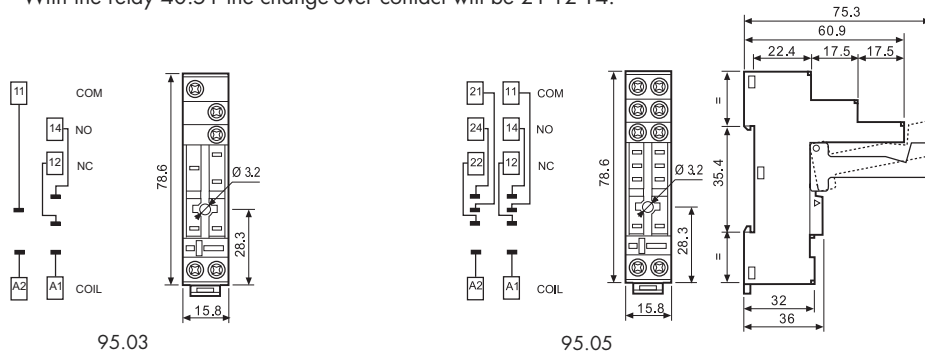

| 8-way jumper link for 95.03 and 95.05 sockets | 095.18 (blue) | 095.18.0 (black) |
|---|---------------|------------------|
| Rated values | 10 A - 250 V | |

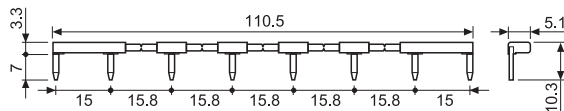

| 86 series timer modules | |
|---|------------------|
| (12...24)V AC/DC; Bi-function: AI, DI; (0.05s...100h) | 86.30.0.024.0000 |
| (110...125)V AC; Bi-function: AI, DI; (0.05s...100h) | 86.30.8.120.0000 |
| (230...240)V AC; Bi-function: AI, DI; (0.05s...100h) | 86.30.8.240.0000 |

Approvals (according to type):

| 99.02 coil indication and EMC suppression modules for 95.03 and 95.05 sockets | | |
|---|--------------------|----------------|
| Diode (+A1, standard polarity) | (6...220)V DC | 99.02.3.000.00 |
| LED | (6...24)V DC/AC | 99.02.0.024.59 |
| LED | (28...60)V DC/AC | 99.02.0.060.59 |
| LED | (110...240)V DC/AC | 99.02.0.230.59 |
| LED + Diode (+A1, standard polarity) | (6...24)V DC | 99.02.9.024.99 |
| LED + Diode (+A1, standard polarity) | (28...60)V DC | 99.02.9.060.99 |
| LED + Diode (+A1, standard polarity) | (110...220)V DC | 99.02.9.220.99 |
| LED + Varistor | (6...24)V DC/AC | 99.02.0.024.98 |
| LED + Varistor | (28...60)V DC/AC | 99.02.0.060.98 |
| LED + Varistor | (110...240)V DC/AC | 99.02.0.230.98 |
| RC circuit | (6...24)V DC/AC | 99.02.0.024.09 |
| RC circuit | (28...60)V DC/AC | 99.02.0.060.09 |
| RC circuit | (110...240)V DC/AC | 99.02.0.230.09 |
| Residual current by-pass | (110...240)V AC | 99.02.8.230.07 |



95.85.3

Approvals
(according to type):



095.91.3



060.72

| Screw terminal (Box clamp) socket panel or 35 mm rail mount | 95.83.3 (blue) | 95.83.30 (black) | 95.85.3 (blue) | 95.85.30 (black) |
|--|---|------------------|---------------------|------------------|
| For relay type | 40.31 | | 40.51, 40.52, 40.61 | |
| Accessories | | | | |
| Metal retaining clip | 095.71 | | | |
| Plastic retaining and release clip (supplied with socket - packaging code SPA) | 095.91.3 | 095.91.30 | 095.91.3 | 095.91.30 |
| 8-way jumper link | 095.08 | 095.08.0 | 095.08 | 095.08.0 |
| Identification tag | 095.80.3 | | | |
| Modules (see table below) | 99.80 | | | |
| Sheet of marker tags for retaining and release clip 095.91.3 plastic, 72 tags, 6x12 mm | 060.72 | | | |
| Technical data | | | | |
| Rated values | 10 A - 250 V * | | | |
| Dielectric strength | 6 kV (1.2/50 µs) between coil and contacts (95.83.3 only) | | | |
| Protection category | IP 20 | | | |
| Ambient temperature | °C -40...+70 | | | |
| Screw torque | Nm 0.5 | | | |
| Wire strip length | mm 7 | | | |
| Max. wire size for 95.83.3 and 95.85.3 sockets | solid wire | | stranded wire | |
| | m ² 1x6 / 2x2.5 | | 1x4 / 2x2.5 | |
| | AWG 1x10 / 2x14 | | 1x12 / 2x14 | |

* For currents >10 A, contact terminals must be connected in parallel (21 with 11, 24 with 14, 22 with 12).
With the relay 40.51 the change-over contact will be 21-12-14.

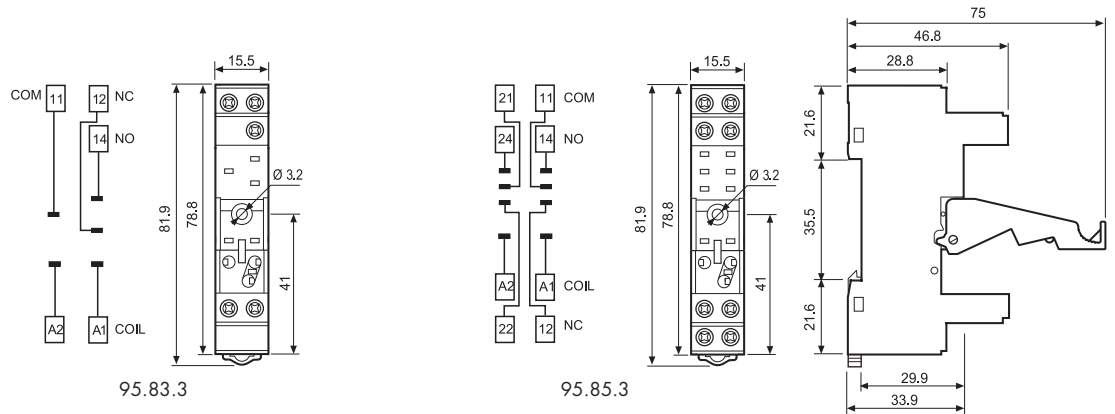

095.08

| 8-way jumper link for 95.83.3 and 95.85.3 sockets | 095.08 (blue) | 095.08.0 (black) |
|---|---------------|------------------|
| Rated values | 10 A - 250 V | |

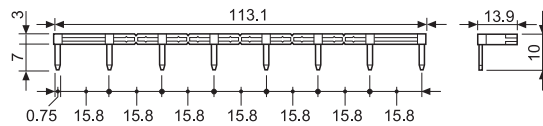

99.80

| 99.80 coil indication and EMC suppression modules for 95.83.3 and 95.85.3 sockets | | |
|---|--------------------|----------------|
| | | Blue* |
| Diode (+A1, standard polarity) | (6...220)V DC | 99.80.3.000.00 |
| LED | (6...24)V DC/AC | 99.80.0.024.59 |
| LED | (28...60)V DC/AC | 99.80.0.060.59 |
| LED | (110...240)V DC/AC | 99.80.0.230.59 |
| LED + Diode (+A1, standard polarity) | (6...24)V DC | 99.80.9.024.99 |
| LED + Diode (+A1, standard polarity) | (28...60)V DC | 99.80.9.060.99 |
| LED + Diode (+A1, standard polarity) | (110...220)V DC | 99.80.9.220.99 |
| LED + Varistor | (6...24)V DC/AC | 99.80.0.024.98 |
| LED + Varistor | (28...60)V DC/AC | 99.80.0.060.98 |
| LED + Varistor | (110...240)V DC/AC | 99.80.0.230.98 |
| RC circuit | (6...24)V DC/AC | 99.80.0.024.09 |
| RC circuit | (28...60)V DC/AC | 99.80.0.060.09 |
| RC circuit | (110...240)V DC/AC | 99.80.0.230.09 |
| Residual current by-pass | (110...240)V AC | 99.80.8.230.07 |

* Modules in Black housing are available on request.

Green LED is standard.
Red LED available on request.

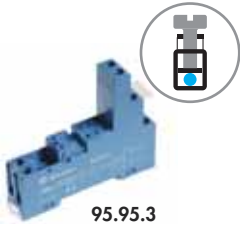

95.95.3

Approvals (according to type):



95.91.3



060.72

| | | | | |
|--|--|-------------------------|-----------------------|-------------------------|
| Screw (Box clamp) terminal socket panel or 35 mm rail mount | 95.93.3 (blue) | 95.93.30 (black) | 95.95.3 (blue) | 95.95.30 (black) |
| For relay type | 40.31 | | 40.51, 40.52, 40.61 | |
| Accessories | | | | |
| Metal retaining clip | 095.71 | | | |
| Plastic retaining and release clip | 095.91.3 | 095.91.30 | 095.91.3 | 095.91.30 |
| 8-way jumper link | 095.08 | 095.08.0 | 095.08 | 095.08.0 |
| Identification tag | 095.80.3 | | | |
| Modules (see table below) | 99.80 | | | |
| Sheet of marker tags for retaining and release clip 095.91.3 plastic, 72 tags, 6x12 mm | 060.72 | | | |
| Technical data | | | | |
| Rated values | 10 A - 250 V * | | | |
| Dielectric strength | 6 kV (1.2/50 µs) between coil and contacts | | | |
| Protection category | IP 20 | | | |
| Ambient temperature | °C -40...+70 | | | |
| ⊕ Screw torque | Nm | 0.5 | | |
| Wire strip length | mm | 8 | | |
| Max. wire size for 95.93.3 and 95.95.3 sockets | | solid wire | stranded wire | |
| | m ² | 1x6 / 2x2.5 | 1x4 / 2x2.5 | |
| | AWG | 1x10 / 2x14 | 1x12 / 2x14 | |

* For currents >10 A, contact terminals must be connected in parallel (21 with 11, 24 with 14, 22 with 12). With the relay 40.51 the change-over contact will be 21-12-14.

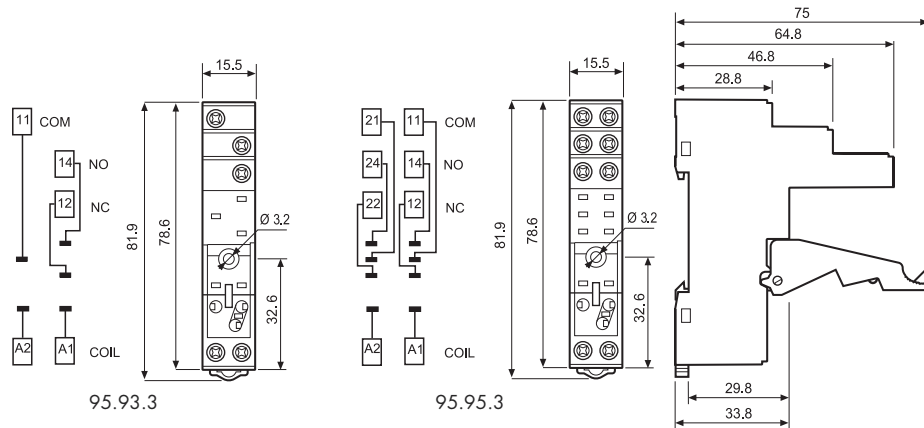

95.08

| | | |
|--|----------------------|-------------------------|
| 8-way jumper link for 95.93.3 and 95.95.3 sockets | 095.08 (blue) | 095.08.0 (black) |
| Rated values | 10 A - 250 V | |

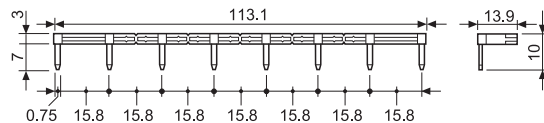

99.80

| 99.80 coil indication and EMC suppression modules for 95.93.3 and 95.95.3 sockets | | Blue* |
|--|--------------------|----------------|
| Diode (+A1, standard polarity) | (6...220)V DC | 99.80.3.000.00 |
| LED | (6...24)V DC/AC | 99.80.0.024.59 |
| LED | (28...60)V DC/AC | 99.80.0.060.59 |
| LED | (110...240)V DC/AC | 99.80.0.230.59 |
| LED + Diode (+A1, standard polarity) | (6...24)V DC | 99.80.9.024.99 |
| LED + Diode (+A1, standard polarity) | (28...60)V DC | 99.80.9.060.99 |
| LED + Diode (+A1, standard polarity) | (110...220)V DC | 99.80.9.220.99 |
| LED + Varistor | (6...24)V DC/AC | 99.80.0.024.98 |
| LED + Varistor | (28...60)V DC/AC | 99.80.0.060.98 |
| LED + Varistor | (110...240)V DC/AC | 99.80.0.230.98 |
| RC circuit | (6...24)V DC/AC | 99.80.0.024.09 |
| RC circuit | (28...60)V DC/AC | 99.80.0.060.09 |
| RC circuit | (110...240)V DC/AC | 99.80.0.230.09 |
| Residual current by-pass | (110...240)V AC | 99.80.8.230.07 |

* Modules in Black housing are available on request.

Green LED is standard. Red LED available on request.



95.55

Approvals
(according to type):



095.91.3

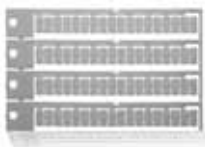

060.72

| | | |
|---|--|------------------------|
| Screwless terminal socket panel or 35 mm rail mount | 95.55 (blue) | 95.55.0 (black) |
| For relay type | 40.51, 40.52, 40.61 | |
| Accessories | | |
| Metal retaining clip | 095.71 | |
| Plastic retaining and release clip (supplied with socket - packaging code SPA) | 095.91.3 | |
| Modules (see table below) | 99.02 | |
| Timer modules (see table below) | 86.30 | |
| Sheet of marker tags for retaining and release clip 095.91.3 plastic, 72 tags, 6x12 mm | 060.72 | |
| Technical data | | |
| Rated values | 10 A - 250 V * | |
| Dielectric strength | 6 kV (1.2/50 µs) between coil and contacts | |
| Protection category | IP 20 | |
| Ambient temperature | °C -25...+70 | |
| Wire strip length | mm | 8 |
| Max. wire size for 95.55 socket | | solid wire |
| | mm ² | 2x(0.2...1.5) |
| | AWG | 2x(24...18) |
| | | stranded wire |
| | | 2x(0.2...1.5) |
| | | 2x(24...18) |

* For currents >10 A, contact terminals must be connected in parallel (21 with 11, 24 with 14, 22 with 12).
With the relay 40.51 the change-over contact will be 21-12-14.

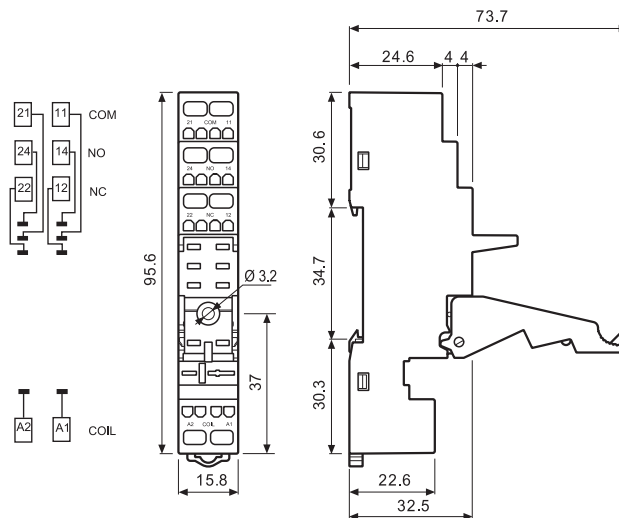

| | | |
|---|------------------|--|
| 86 series timer modules | | |
| (12...24)V AC/DC; Bi-function: AI, DI; (0.05s...100h) | 86.30.0.024.0000 | |
| (110...125)V AC; Bi-function: AI, DI; (0.05s...100h) | 86.30.8.120.0000 | |
| (230...240)V AC; Bi-function: AI, DI; (0.05s...100h) | 86.30.8.240.0000 | |

Approvals
(according to type):

| | | |
|---|--------------------|----------------|
| 99.02 coil indication and EMC suppression modules for 95.55 socket | | |
| Diode (+A1, standard polarity) | (6...220)V DC | 99.02.3.000.00 |
| LED | (6...24)V DC/AC | 99.02.0.024.59 |
| LED | (28...60)V DC/AC | 99.02.0.060.59 |
| LED | (110...240)V DC/AC | 99.02.0.230.59 |
| LED + Diode (+A1, standard polarity) | (6...24)V DC | 99.02.9.024.99 |
| LED + Diode (+A1, standard polarity) | (28...60)V DC | 99.02.9.060.99 |
| LED + Diode (+A1, standard polarity) | (110...220)V DC | 99.02.9.220.99 |
| LED + Varistor | (6...24)V DC/AC | 99.02.0.024.98 |
| LED + Varistor | (28...60)V DC/AC | 99.02.0.060.98 |
| LED + Varistor | (110...240)V DC/AC | 99.02.0.230.98 |
| RC circuit | (6...24)V DC/AC | 99.02.0.024.09 |
| RC circuit | (28...60)V DC/AC | 99.02.0.060.09 |
| RC circuit | (110...240)V DC/AC | 99.02.0.230.09 |
| Residual current by-pass | (110...240)V AC | 99.02.8.230.07 |



86.30



99.02

Approvals
(according to type):



DC Modules with
non-standard polarity
(+A2) on request.



95.55.3

Approvals (according to type):



095.91.3



060.72

| | | | |
|--|--|-------------------------|---------------|
| Screwless terminal socket panel or 35 mm rail mount | 95.55.3 (blue) | 95.55.30 (black) | |
| For relay type | 40.51, 40.52, 40.61 | | |
| Accessories | | | |
| Metal retaining clip | 095.71 | | |
| Plastic retaining and release clip (supplied with socket - packaging code SPA) | 095.91.3 | | |
| Modules (see table below) | 99.80 | | |
| Sheet of marker tags for retaining and release clip 095.91.3 plastic, 72 tags, 6x12 mm | 060.72 | | |
| Technical data | | | |
| Rated values | 10 A - 250 V * | | |
| Dielectric strength | 6 kV (1.2/50 µs) between coil and contacts | | |
| Protection category | IP 20 | | |
| Ambient temperature °C | -25...+70 | | |
| Wire strip length mm | 8 | | |
| Max. wire size for 95.55.3 socket | solid wire | stranded wire | |
| | mm ² | 2x(0.2...1.5) | 2x(0.2...1.5) |
| | AWG | 2x(24...18) | 2x(24...18) |

* For currents >10 A, contact terminals must be connected in parallel (21 with 11, 24 with 14, 22 with 12). With the relay 40.51 the change-over contact will be 21-12-14.

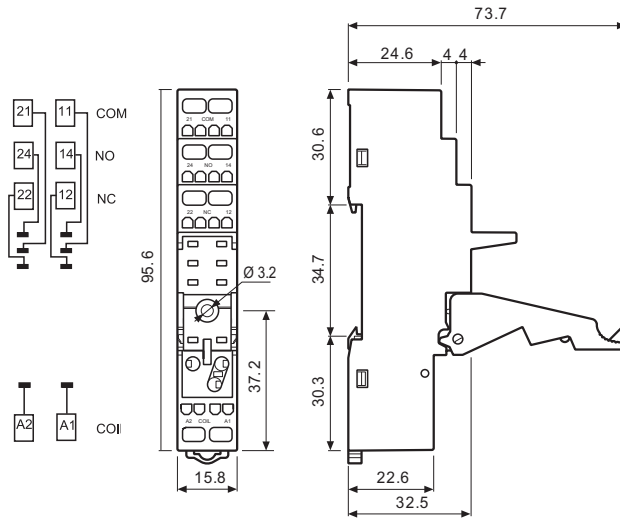

99.80

| 99.80 coil indication and EMC suppression modules for 95.55.3 socket | | Blue* |
|--|--------------------|----------------|
| Diode (+A1, standard polarity) | (6...220)V DC | 99.80.3.000.00 |
| LED | (6...24)V DC/AC | 99.80.0.024.59 |
| LED | (28...60)V DC/AC | 99.80.0.060.59 |
| LED | (110...240)V DC/AC | 99.80.0.230.59 |
| LED + Diode (+A1, standard polarity) | (6...24)V DC | 99.80.9.024.99 |
| LED + Diode (+A1, standard polarity) | (28...60)V DC | 99.80.9.060.99 |
| LED + Diode (+A1, standard polarity) | (110...220)V DC | 99.80.9.220.99 |
| LED + Varistor | (6...24)V DC/AC | 99.80.0.024.98 |
| LED + Varistor | (28...60)V DC/AC | 99.80.0.060.98 |
| LED + Varistor | (110...240)V DC/AC | 99.80.0.230.98 |
| RC circuit | (6...24)V DC/AC | 99.80.0.024.09 |
| RC circuit | (28...60)V DC/AC | 99.80.0.060.09 |
| RC circuit | (110...240)V DC/AC | 99.80.0.230.09 |
| Residual current by-pass | (110...240)V AC | 99.80.8.230.07 |

* Modules in Black housing are available on request.

Green LED is standard. Red LED available on request.

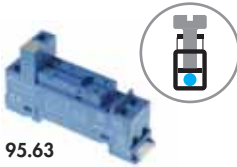

95.63

Approvals
(according to type):

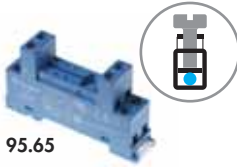

95.65

Approvals
(according to type):



| | | | |
|--|---------------------|---------------------|-------------|
| Screw terminal (Box clamp) socket panel or 35 mm rail mount | 95.63 (blue) | 95.65 (blue) | |
| For relay type | 40.31 | 40.51, 40.52, 40.61 | |
| Accessories | | | |
| Metal retaining clip | 095.71 | | |
| 8-way jumper link | 095.08 | 095.08 | |
| Modules (see table below) | 99.01 | — | |
| Technical data | | | |
| Rated values | 10 A - 250 V * | | |
| Dielectric strength (between coil and contacts) | 6 kV (1.2/50 µs) | 2 kV AC | |
| Protection category | IP 20 | | |
| Ambient temperature | °C -40...+70 | | |
| ⊕ Screw torque | Nm | 0.5 | |
| Wire strip length | mm | 7 | |
| Max. wire size for 95.63 and 95.65 sockets | solid wire | stranded wire | |
| | m ² | 1x6 / 2x2.5 | 1x4 / 2x2.5 |
| | AWG | 1x10 / 2x14 | 1x12 / 2x14 |

* For currents >10 A, contact terminals must be connected in parallel (21 with 11, 24 with 14, 22 with 12).
With the relay 40.51 the change-over contact will be 21-12-14.

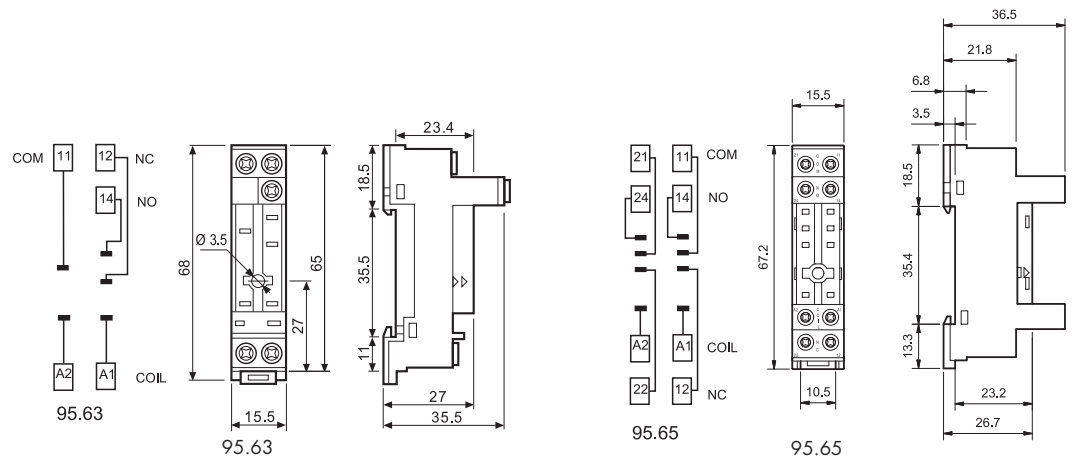

095.08

| | |
|--|----------------------|
| 8-way jumper link for 95.63 and 95.65 sockets | 095.08 (blue) |
| Rated values | 10 A - 250 V |

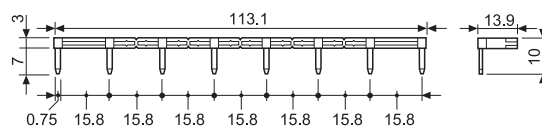

99.01

| 99.01 coil indication and EMC suppression modules for type 95.63 socket | | Blue* |
|---|--------------------|----------------|
| Diode (+A1, standard polarity) | (6...220)V DC | 99.01.3.000.00 |
| Diode (+A2, non-standard polarity) | (6...220)V DC | 99.01.2.000.00 |
| LED | (6...24)V DC/AC | 99.01.0.024.59 |
| LED | (28...60)V DC/AC | 99.01.0.060.59 |
| LED | (110...240)V DC/AC | 99.01.0.230.59 |
| LED + Diode (+A1, standard polarity) | (6...24)V DC | 99.01.9.024.99 |
| LED + Diode (+A1, standard polarity) | (28...60)V DC | 99.01.9.060.99 |
| LED + Diode (+A1, standard polarity) | (110...220)V DC | 99.01.9.220.99 |
| LED + Diode (+A2, non-standard polarity) | (6...24)V DC | 99.01.9.024.79 |
| LED + Diode (+A2, non-standard polarity) | (28...60)V DC | 99.01.9.060.79 |
| LED + Diode (+A2, non-standard polarity) | (110...220)V DC | 99.01.9.220.79 |
| LED + Varistor | (6...24)V DC/AC | 99.01.0.024.98 |
| LED + Varistor | (28...60)V DC/AC | 99.01.0.060.98 |
| LED + Varistor | (110...240)V DC/AC | 99.01.0.230.98 |
| RC circuit | (6...24)V DC/AC | 99.01.0.024.09 |
| RC circuit | (28...60)V DC/AC | 99.01.0.060.09 |
| RC circuit | (110...240)V DC/AC | 99.01.0.230.09 |
| Residual current by-pass | (110...240)V AC | 99.01.8.230.07 |

* Modules in Black housing are available on request.

Green LED is standard. Red LED available on request.



95.13.2



95.15.2

Approvals
(according to type):



| PCB socket | 95.13.2 (blue) | 95.13.20 (black) | 95.15.2 (blue) | 95.15.20 (black) |
|--|--|------------------|---------------------|------------------|
| For relay type | 40.31, 40.41 | | 40.51, 40.52, 40.61 | |
| Accessories | | | | |
| Metal retaining clip (supplied with socket - packaging code SMA) | | | 095.51 | |
| Plastic retaining clip | | | 095.52 | |
| Technical data | | | | |
| Rated values | 10 A - 250 V * | | | |
| Dielectric strength | 6 kV (1.2/50 μs) between coil and contacts | | | |
| Protection category | IP 20 | | | |
| Ambient temperature | °C -40...+70 | | | |

* For currents > 10 A, contact terminals must be connected in parallel (21 with 11, 24 with 14, 22 with 12).
With the relay 40.51 the change-over contact will be 21-12-14.

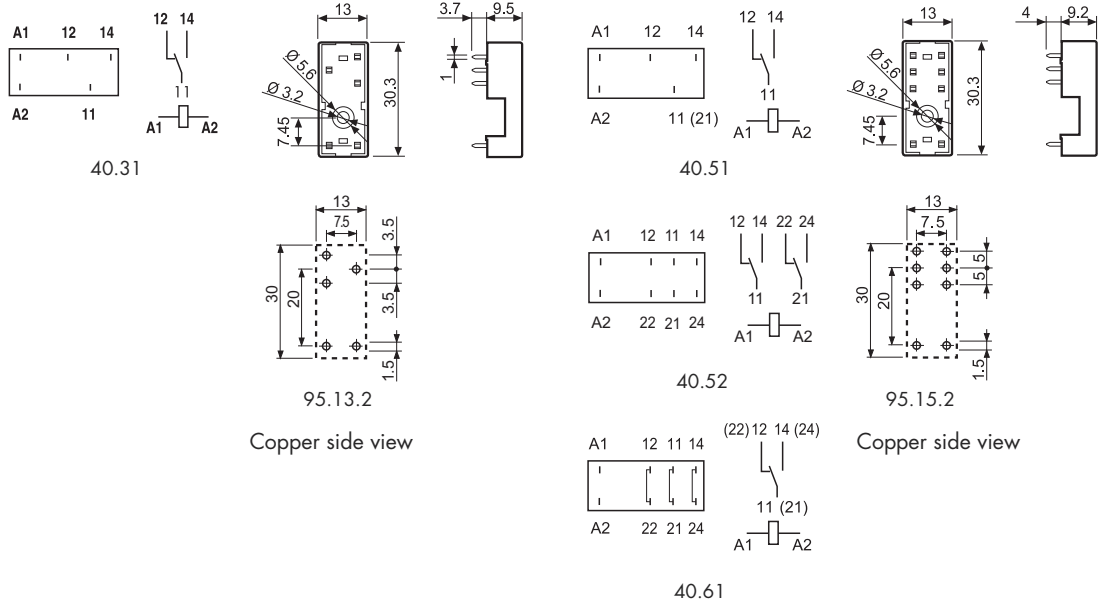

Packaging codes

How to code and identify retaining clip and packaging options for sockets.

Example:

