



**HDS-N Series Handheld Digital Storage
Oscilloscope & Multimeter
User Manual**

- **HDS1022M-N**
- **HDS2062M-N**
- **HDS3102M-N**

WWW.OWON.COM.CN

Dec. 2009 edition

Copy Right in this Manual © Lilliput Company. All rights have been reserved.

The Lilliput's products are under the protection of the patent rights in America and other countries, including ones which have already obtained the patent rights and those which are applying for. The information in this manual will replace all that in the materials published originally.

The information in this manual was correct at the time of printing. However, OWON will continue to improve products and reserves the rights to changes specification at any time without notice.

OWON is the registered trademark of the Lilliput Company.

Xiamen Lilliput Technology Co.,Ltd.: the 5th floor, B Area, Chuangxin Mansion, Software Park,ZhenZhuWan, Huandao RD, Xiamen,Fujian,China

Fujian Lilliput Optoelectronics Technology Co.,Ltd.:The mansion of optoelectronics hengsan road, Lantian industrial zone ,Zhangzhou,Fujian,China

Tel:+86-592-2575666

Fax:+86-592-2575669

Mail:sales@owon.com.cn

General Warranty

The Lilliput warrants that the product will be free from defects in materials and workmanship for a period of three years from the date of purchase of the product by the original purchaser from the Lilliput company. And the warranty period of accessories such as probe, battery, adapter is one year. This warranty only applies to the original purchaser and is not transferable to the third party. If the product proves defective during the warranty period, Lilliput either will repair the defective product without charge for parts and labor, or will provide a replacement in exchange for the defective product. Parts, modules and replacement products used by Lilliput for warranty work may be new or reconditioned to like new performance. All replaced parts, modules and products become the property of Lilliput.

In order to obtain service under this warranty, Customer must notify Lilliput of the defect before the expiration of the warranty period. Customer shall be responsible for packaging and shipping the defective product to the service center designated by Lilliput, and with a copy of customer proof of purchase.

This warranty shall not apply to any defect, failure or damage caused by improper use or improper or inadequate maintenance and care. Lilliput shall not be obligated to furnish service under this warranty a) to repair damage resulting from attempts by personnel other than Lilliput representatives to install, repair or service the product; b) to repair damage resulting from improper use or connection to incompatible equipment; c) to repair any damage or malfunction caused by the use of non-Lilliput supplies; or d) to service a product that has been modified or integrated with other products when the effect of such modification or integration increases the time or difficulty of servicing the product.

Please contact the nearest Lilliput's Sales and Service Offices for services or a complete copy of the warranty statement.

Excepting the after-sales services provided in this summary or the applicable warranty statements, Lilliput will not offer any guarantee for maintenance definitely declared or hinted, including but not limited to the implied guarantee for marketability and special-purpose acceptability. Lilliput should not take any responsibilities for any indirect, special or consequent damages.

Table of Contents

Chapter	Page
1. DECLARATION OF CONFORMITY	1
1.1 Declaration of Conformity	1
1.2 Package Contents (see the picture below)	1
2. SAFETY INFORMATION	2
2.1 Safety Symbols and Terms	2
2.1.1 Safety Symbols.....	2
2.1.2 Safety Terms.....	2
2.2 General Safety Information	3
3. GENERAL CHARACTERISTICS	5
4.PERFORMING THE GENERAL INSPECTION	6
4.1 Performing the General Inspection	6
4.1.1 Check whether there is any Damage on it Due to Transportation.....	6
4.1.2 Make a Check on Accessories	6
4.1.3 Make a Check on the Complete Instrument.....	6
5. INPUT CONNECTIONS	7
5.1 Input Connections	7
5.1.1 Input connections.....	7
5.1.2 The connection of 1KHz/5V Square-wave test signal	8
5.2 Front Panel and Keys Overview	8
6. USING THE OSCILLOSCOPE	11
6.1 About this Chapter.....	11
6.2 Powering Up the Oscilloscope.....	11
6.3 Oscilloscope Operation Window.....	11
6.4 Menu Description.....	13
6.5 Manually Setting the Vertical System, Horizontal System and Trigger Position	14
6.6 Recall factory settings.....	17
6.7 Input Connections.....	17
6.8 Displaying an Unknown Signal with Auto Set.....	18
6.9 Automatic Zero-returning of Trigger Horizontal Position and Trigger Level Position	18
6.10 Automatic Measurements.....	18
6.11 Freezing the Screen.....	19
6.12 Using Average for Smoothing Waveforms.....	20

6.13 Using Persistence to Display Waveforms	20
6.14 Using Peak Detection to Display Glitches	21
6.15 Selecting AC-coupling	22
6.16 Reversing the Polarity of the Displayed Waveform	23
6.17 Using Waveform Mathematics Functions	24
6.18 Use USB mass storage device to save waveform data	25
7. USING THE MULTIMETER	26
7.1 About this Chapter	26
7.2 Making Meter Connections	26
7.3 Multimeter Operation Window	26
7.4 Making Multimeter Measurements	27
7.4.1 Measuring Resistance Values	27
7.4.2 Measuring Diode	28
7.4.3 On-off Test	29
7.4.4 Measuring Capacitance	29
7.4.5 Measuring DC Voltage	30
7.4.6 Measuring AC Voltage	31
7.4.7 Measuring DC Current	32
7.4.8 Measuring AC Current	33
7.5 Freezing the Readings	34
7.6 Taking a Relative Measurement	35
7.7 Selecting Automatic/Manual Range Adjustment	36
8. ADVANCED FUNCTION OF OSCILLOSCOPE	3 7
8.1 About this Chapter	3 7
8.2 Setting the Vertical CH1 and CH2	3 7
8.2.1 Setting the Channel Coupling	3 8
8.2.2 Open and Close Settings on Channel	3 9
8.2.3 Setting the probe attenuation	3 9
8.2.4 Setting of Inverted Waveform	4 0
8.3 Make the Math Function Menu Setting	4 0
8.4 Setting the Trigger System	4 1
8.5 Triggering Control	4 2
8.5.1 Edge Triggering	4 2
8.5.2 Video Triggering	4 3
8.5.3 Alternate trigger	4 5
8.6 Selecting the acquisition mode	4 8
8.7 Display Setting	4 8
8.7.1 Display Style	4 9
8.7.2 Persistence	5 0
8.7.3 XY Mode	5 0
8.7.4 Cymometer(Only for the HDS2062M-N and HDS3102M-N)	5 0

8.8 Waveform Saving Setups	5 1
8.8.1 Waveform Saving Setups in normal mode	5 1
8.8.2 Waveform Saving Setups in FFT mode	5 3
8.9 Function Setting Menu	5 4
8.10 Making Automatic Measurements	5 4
8.11 Setting the Cursor Measurements	5 6
8.11.1 Setting the cursor measurement in normal mode	5 6
8.11.2 Setting the cursor measurement in FFT mode	5 9
8.12 Autoscale	6 0
8.13 Record(only for the HDS2062M-N and HDS3102M-N)	6 3
8.14 Using FFT	6 6
8.15 System State Menu	7 2
8.15.1 Real time clock	7 3
8.16 Setting of Time Base Mode	7 3
8.17 Data Transmission	7 5
9. TROUBLE SHOOTING	76
10. APPENDIX	77
10.1 Appendix A: Specifications	77
10.1.1 Oscilloscope	77
10.1.2 Meter	79
10.1.3 General Specifications	81
10.2 Appendix B: Maintenance and Cleaning	83
10.2.1 Maintenance	83
10.2.2 Storage of Oscilloscope	83
10.2.3 Replacing the Lithium Battery Unit	83

1. Declaration of Conformity

1.1 Declaration of Conformity

HDS-N Series Handheld Digital Storage Oscilloscope & Multimeter

Manufacturer: Fujian Lilliput Optoelectronic Technology Co., Ltd.

Statement of Conformity

Base on the result using appropriate standards, the product is in conformity with
Electromagnetic Compatibility Directive 89/336/EEC
Low Voltage Directive 73/23/EEC

Sample tests

Standards used:

EN61010.1: 2001 (2nd edition)

Safety Requirements for Electrical Equipment for Measurement, Control, and
Laboratory use-part 1: General Requirements

EN61326: 1997+A1: 1998+A2: 2001+A3: 2003

Electrical Equipment for Measurement, Control and Laboratory use-EMC
Requirements-part 1. General Requirements

EN61000-3-2: 2000+A2: 2005

Electromagnetic Compatibility(EMC)-part 3:Limits-Section 2: Limits for Harmonic
Current Emissions (Equipment Input Current less than/equal to 16A per phase)

EN61000-3-3: 1995+A1: 2001

Electromagnetic Compatibility (EMC)-part 3:Limits-Section 3 Limitation of Voltage
Fluctuations and Flicker in Low-Voltage Supply systems for Equipment with Rated
Current less than or equal to 16A

The tests have been performed in typical configuration.

This conformity is indicated by the symbol CE, i.e."Conformite Europeenne".

1.2 Package Contents (see the picture below)

#	Description	Standard	Optional
1	Oscilloscope and Battery	•	
2	AC-DC adapter	•	
3	Oscilloscope Probe x 2 (grey)	•	
4	Multimeter test lead x 2 (black and red)	•	
5	USB Mass Storage connect cable	•	
6	Extension module for small capacitance measurement	•	
7	Probe adjustment tools	•	
8	USB communication cable or RS-232C communication cable	•	
9	User Manual	•	
10	CD-ROM (software)	•	
11	Hard carrying case		•
12	Soft carrying case		•
13	the output terminal of 1KHz 5V square-wave test signal	•	



Figure 1: Digital Oscilloscope Parts

2. Safety Information

In order to ensure the correct using and the best efficient service, please carefully read this user's manual.





2.1 Safety Symbols and Terms

2.1.1 Safety Symbols

These symbols may appear in this manual or on the instrument.

 **Warning:** “Warning” identifies conditions and actions that pose hazards to the users.

 **Caution:** “Caution” identifies conditions and actions that may damage the product or other properties.

DANGER: High Voltage	Refer to the Manual	Protective Conductor Terminal	Chassis Ground	Earth (ground) Terminal
				

2.1.2 Safety Terms.

The following terms may appear on the instrument:

- Danger:** The term “Danger” is used in this manual to indicate that when you read this mark, personal injury may be caused to you immediately.
- Warning:** The term “Warning” is used in this manual to indicate that when you read this mark, personal injury may not be caused to you immediately, but you need to be cautionary.
- Notice:** The term “Notice” is used in this manual to indicate that damages may be caused on this product or other properties.

2.2 General Safety Information

Carefully read the following safety information in order to avoid any personal injury and damage on this product or any products connected with it. This product can only be used in the specified applications to prevent any possible dangers.



Warning:

To avoid fire or electrical shock. Please use proper power adapter. Use only the power adapter appointed by the manufacturer and subject to approval of being used in the user's country.



Warning:

To avoid fire or electrical shock if a test tool input is connected to more 42V peak (30Vrms) or on circuits of more than 4800VA:

- **Use only insulated voltage probes, test leads and adapter supplied with the test tool, or indicated by OWON as suitable for the Oscilloscope & Multimeter.**
- **Before use, inspect voltage probes, test leads and accessories for mechanical damage and replace when damaged.**
- **Remove all probes, test leads and accessories that are not in use.**
- **Always connect the power adapter first to the AC outlet before connecting it to the Oscilloscope & Multimeter.**
- **Do not apply voltages that differ more than 400 V from earth ground to any input when measuring in a CAT II environment.**
- **Do not apply voltages that differ more than 400 V from each other to the isolated inputs when measuring in a CAT II environment.**
- **Do not apply input voltages above the rating of the instrument Use caution when using 1:1 test leads because the probe tip voltage will be directly transmitted to the Oscilloscope & Multimeter.**
- **Do not use exposed metal BNC or banana plug connectors.**
- **Do not insert metal objects into connectors.**
- **Always use the Oscilloscope & Multimeter only in the manner specified.**
- **Voltage ratings that are mentioned in the warning are given as limits for “working voltage”. The represent V ac rms (50-60Hz) for AC sine wave applications and as V dc for DC applications. Overvoltage Category II refers to local level , which is applicable for appliances and portable equipment .**

Only qualified technical personnel are permitted to perform maintenance.

Pay attention to the nominal values of all terminals: To avoid fire or electric shock, please keep a watchful eye on all nominal values and marks specified for this product. Before any connection performed on this product, carefully read the user's manual of the product for further information of nominal values.

No operation is allowed without the instrument cover plate: If the cover plate or panel has been removed, do not perform any operation on this product.

No touch is allowed on bare conductors: When the product is powered on, do not touch any bare joints or parts of the scope meter.

Operation is prohibited in case of any undetermined failure: When in doubt any damage on this product, consult the qualified personnel for checking on it.

Keep ventilation in good condition: Refer to the user manual for detail installation instructions in order to fix this product correctly and provide it with good ventilation conditions.

No operation is allowed under a humid environment.

No operation is allowed under an explosive environment.

Keep clean and dry on the product surface.

The method which stipulated according to the factory does not use the equipment, possibly can damage the protection which the equipment provides.

3. General Characteristics

Oscilloscope

- 2 in 1 (Multimeter function support);
- Record length of 6,000 points for each channel;
- Reading-out with the cursor;
- Twenty automatic measurement functions;
- Autoscale function;
- Color liquid crystal display of high resolution and high contrast with adjustable back light;
- Storage and call-out of waveforms;
- Automatic setting function provided capable of fast setting;
- Multiple-waveform calculation function;
- Implementation of detecting the average and peak values of the waveform;
- Edge, video and alternate triggering function;
- RS232 or USB communication ports;
- Multiple Language User Interface.

Multimeter

- 3 3/4 digits;
- Volts,Amps,Ohms,Diode,Capacitance,Continuity measurement;
- 10A maximum amplitude;
- Isolated inputs between oscilloscope and multimeter.

4.Performing the General Inspection

4.1 Performing the General Inspection

When you have got a new HDS-N series oscilloscope, it is suggested that you should perform a general inspection on the instrument according to the following steps.

4.1.1 Check whether there is any Damage on it Due to Transportation

If the packing boxes or foam cushions are found in serious damage, keep them in a proper place till the complete instrument and accessories have passed the electrical and mechanical tests.

4.1.2 Make a Check on Accessories

The accessory list has been described in the picture of Digital Oscilloscope Parts of this manual. You can make a check and find whether there is any accessory loss with reference to the Appendix. In case of any accessory loss or damage, consult the OWON dealer responsible for such a business or the local office of OWON.

4.1.3 Make a Check on the Complete Instrument

If the instrument is damaged in its appearance or it fails in normal operation or performance test, consult the OWON dealer responsible for such a business or the local office of OWON. If the instrument is damaged due to transportation, keep the packing in a proper place and consult the transportation department and the OWON dealer responsible for such business, who will provide an instrument replacement or maintenance.

5. Input Connections

5.1 Input Connections

5.1.1 Input connections

See the following figure 2:



Figure 2

Description:

1. The power adapter is supplied for AC power supply and battery recharging.
2. Multimeter test lead.
3. Multimeter input jacks, including four circular banana jacks. The first jack measuring the current 2 A-10A, the second jack on the current Measurement, the third COM ground input, and the fourth measuring voltage, resistance, Capacitance input.
4. Oscilloscope probes.
5. Oscilloscope channel inputs: the upper one is for Channel 1 (CH1), while the lower one is for Channel 2 (CH2).
6. The output terminal of 1KHz/5V square-wave test signal.

5.1.2 The connection of 1KHz/5V Square-wave test signal

At the left side of the oscilloscope, it is a port for testing 1KHz/5V square-wave signal which is used to adjust the probe, shown as Fig.3



Fig.3. The connection of Square-wave test signal

5.2 Front Panel and Keys Overview

See the following figure 4:



Figure 4

Description:

1. AC adapter Port
2. RS-232C Port.
3. USB Port.
4. USB Mass Storage Port.
5. Power switch.
6. F1~F5: Switch or Adjust options for each menu.
7. AUTO SET: Under DSO mode, Automatically selects the horizontal scales, vertical scale, and trigger level according to the input signal.

8. COPY: Press to save the waveform data into the USB Mass Storage Device.
9. ▲ (Red): Adjust horizontal scale in Channel 1.
10. VOLTS POSITION (Red): Switch between voltage and horizontal scale in Channel 1.
11. ▼ (Red): Adjust horizontal scale in Channel 1.
12. ▲ (Blue): Adjust horizontal scale in Channel 2.
13. VOLTS POSITION (Blue): Switch between voltage and horizontal scale in Channel 2.
14. ▼ (Blue): Adjust horizontal scale in Channel 2.
15. RUN/STOP: key for running or stopping the operation
16. LIGHT: Light switch.
17. DMM/OSC: Operation mode switching key between oscilloscope and multimeter.
18. MENU ▲: Choose the upper item on the menu list.
19. MENU: Show / Hide the menu
20. MENU ▼: Choose the lower item on the menu list.
21. OPTION: the key for DSO setting and combines with four arrow keys. Then to set main time base, trigger horizontal position and trigger vertical position. Furthermore the keys possible to adjust the display multiplying factors of M waveform (CHM) and display vertical position (CHM ZERO) during waveform calculation and to adjust cursor 1 (V1 or T1) and cursor 2 (V2 or T2) position during cursor measurement.
22. ▲(yellow): Oscilloscope display upward adjustment key.
23. ▼(yellow): Oscilloscope display downward adjustment key.
24. ►(yellow): Oscilloscope right-direction adjustment key.
25. ◀(yellow): Oscilloscope left-direction adjustment key.
26. A: Selects DMM current measurement
27. V: Selects DMM voltage measurement
28. R: Selects DMM impedance, diode, continuity and capacitance measurement
29. SET: convert AC and DC during measure current or voltage in Multi-meter; convert resistance, diode, on-off and capacitance measure during resistance measuring.

6. Using the Oscilloscope

6.1 About this Chapter

This chapter provides a step-by-step introduction to the scope functions. The introduction does not cover all of the capabilities of the scope functions but gives basic examples to show how to use the menus and perform basic operations.

6.2 Powering Up the Oscilloscope

Connect oscilloscope to AC power via AC-DC adapter as shown in Figure 1. (The oscilloscope may still work with built-in Li-ion battery even without AC power supply).

Turn the oscilloscope on by pressing down the power on/off key .

The instrument then performs Selfchecking after power on. A greeting window and a sentence “press any key to continue……” will display on the screen when the system finishes selfchecking. The users can press any key to enter the measuring function.

The oscilloscope is powered up in its last setup configuration.

6.3 Oscilloscope Operation Window

See the following figure 5:

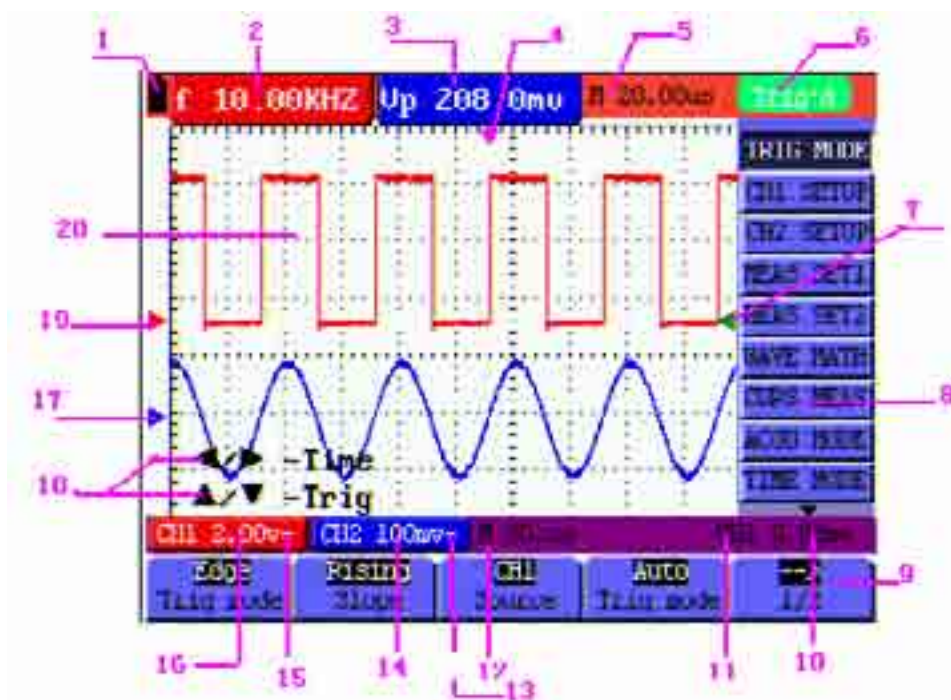









Figure 5: Oscilloscope Operation Window

Description:

1. Battery electric quantity indicating symbols, including , ,  and .
2. Auto measurement window 1, in which “f” means frequency, “T” means cycle, “V” means the average value, “Vp” the peak-peak value, “Vk” the root-mean-square value, “Ma” the maximum amplitude value, “Mi” the minimum amplitude value, “Vt” the Voltage value of the waveform’s flat top value, “Vb” the Voltage value of the waveform’s flat base, “Va” the amplitude value, “Os” the overshoot value, “Ps” the Preshoot value, “RT” the rise time value, “FT” the fall time value, “PW” the +width value, “NW” the -Width value, “+D” the +Duty value, “-D” the -Duty value, “PD” the DelayA-B  value and “ND” the DelayA-B  value.
3. Auto measurement window 2.
4. The pointer indicates the horizontal triggering position.
5. This reading gives the Time Difference between the horizontal triggering position and the screen centerline. It reads zero when the pointer is in the center of the screen.
6. The trigger state indicates the following information.

Auto: The oscilloscope is working in the automatic mode and displaying the waveform under the non-trigger state.

Trig’d: The oscilloscope has detected a trigger and collecting the information generated after the trigger.

Ready: All pre-triggered data have been captured and the oscilloscope has been ready to receive trigger signals.

Scan: The oscilloscope can gather and display the waveform data continuously in scanning mode.

Stop: The oscilloscope has stopped collecting the waveform data.
7. Red and blue index display triggers vertical position during alternate trigger and triggers index become green when it reaches edge trigger or video trigger.
8. A hidden-style menu: With the **MENU** key pressed, you can view or hide the menu.
9. Menu setting options: There are different setting options for different menus.
10. It reads the value of trigger voltage level.
11. The display shows the trigger signal source.
12. The reading gives the value of primary time base.
13. These graphics present the coupling modes of channel 2(CH2). The graphic “~” indicates AC, the graphic “—” indicates DC, the graphic “ ” indicates GND.
14. This reading shows the vertical Voltage Unit Scale of CH2.

15. These graphics show the coupling mode of CH1, among which the graphic “~” express indicates AC, the graphic “—” indicates DC, the graphic “≡” indicates GND.
16. This reading shows the vertical Voltage Unit Scale of CH1.
17. The blue pointer gives the grounding datum point of the waveform on CH2, which is the zero position of CH2. No display of this pointer indicates that the channel has not been opened.
18. OPTION operation prompt: There are different prompts for different OPTION operations.
19. The red pointer gives the grounding datum point of the waveform on CH1, which is the zero position of CH1. No display of this pointer indicates that the channel has not been opened.
20. Waveform display area. Red waveform represent CH1, blue waveform represent CH2.

6.4 Menu Description

The following example shows how to use the tool’s menus to select a function, as shown in the following figure.

1. Press the **MENU** key to display the Function Menu on the right of the screen and the corresponding optional settings on the bottom. Press **MENU** again will hide the Function Menu.
2. Press the **MENU ▲** or **MENU ▼** key to select different function menus.
3. Choose one key from **F1** to **F5** and press it to change function setting.

See the following figure 6:

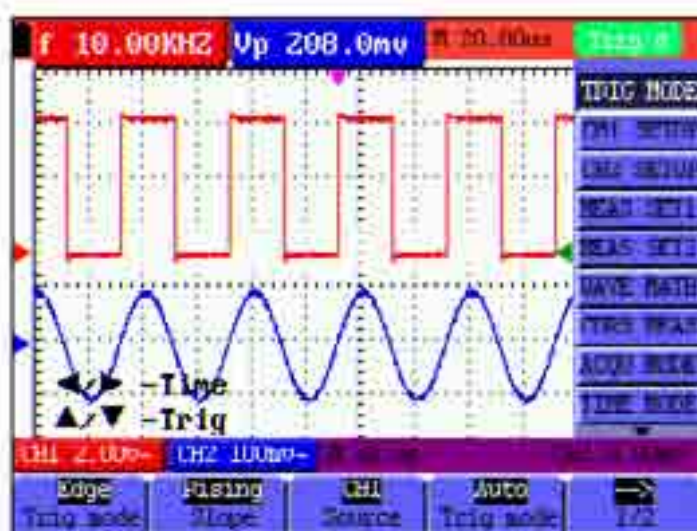

Figure 6: the Tool’s Menus

6.5 Manually Setting the Vertical System, Horizontal System and Trigger Position

OPTION key for multiple setting key and to set trigger vertical position, main time base and horizontal position (trigger horizontal position) during edge trigger and video trigger or trigger vertical position for Horizontal time base and trigger vertical position and horizontal level position during alternate trigger.

The following example shows how to use **OPTION** key to make a setting.

The following guidance is for the operation on the mode of edge triggering and video triggering.

1. Press once the **OPTION** key; the following is displayed at the bottom left side of the screen, as shown in the figure below.

◀/▶ – Time Base

▲/▼ – Trig

See the following figure 7:

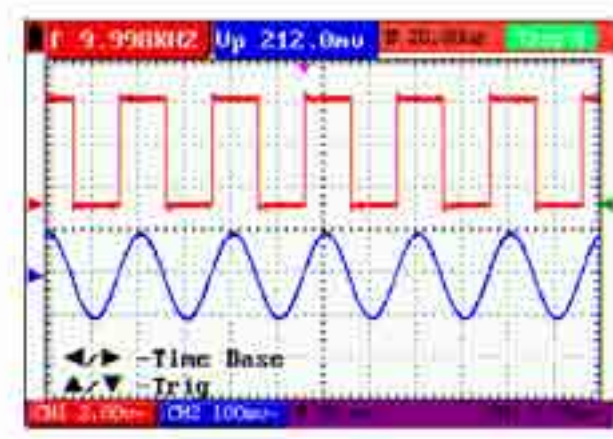

Figure 7

2. Press ◀(yellow) or ▶(yellow) to adjust the main time base and press ▲(yellow) or ▼(yellow) to adjust trigger horizontal position.
3. Press **OPTION** again and left bottom side display as

◀/▶ – **Time**

▲/▼ – **Trig**

See the following figure 8:

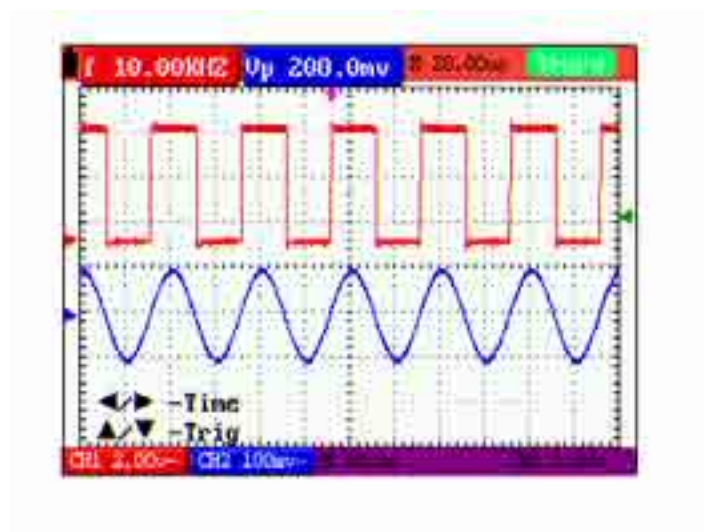

figure 8

4. Press ◀(yellow) or ▶(yellow) to adjust time base horizontal position, press▲(yellow) or ▼(yellow) to adjust trigger position.
5. Press OPTION again to back up operation 1.

The following guidance is for the operation on the mode of alternative triggering.

6. Press OPTION and left bottom display as:

◀/▶—Time

▲/▼—Trig 1

See the following figure 9:

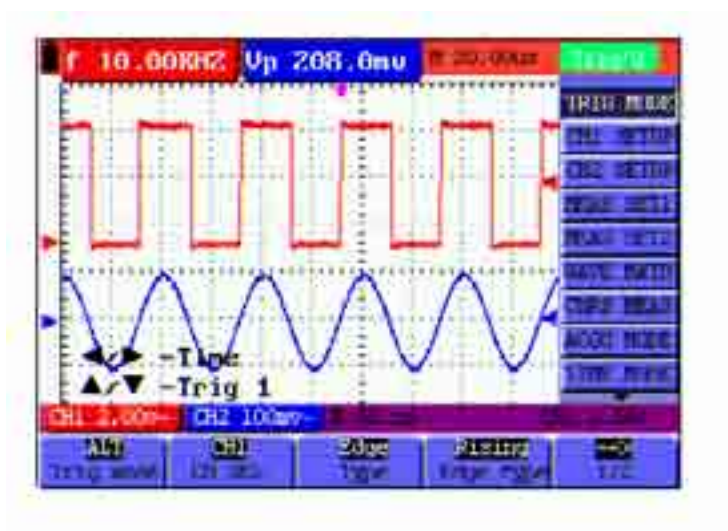

figure 9:

7. Press ◀ (yellow) or ▶ (yellow) to adjust time base horizontal position and press ▲ (yellow) or ▼ (yellow) to adjust trigger horizontal position in Channel 2.
8. Press OPTION again and left bottom display as:

◀/▶ — Time Base

▲/▼ — Trig 2

See the following figure 10:

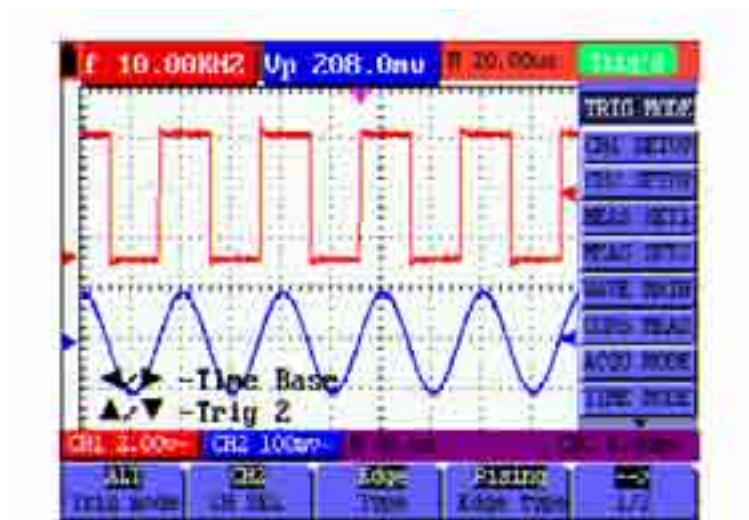

figure 10:

9. Press ◀ (yellow) or ▶ (yellow) to adjust main time base and press ▲ (yellow) or ▼ (yellow) to adjust trigger horizontal position in Channel 1.
10. Press OPTION again to back up operation 6.

Term interpretation

- **Vertical scale factor:** It stands for the voltage amplitude represented by a division in the vertical direction of the display area, through the adjustment of which you can amplify or attenuate the signal and thus regulate the signal amplitude into the expected measurement range.
- **Vertical zero position:** It is referred to as the grounding datum point, through the adjustment of which you can regulate the display position of the waveform on the screen.
- **Main time base:** It means the time values represented by a division in the horizontal direction of the display area.
- **Trigger horizontal position:** It means the time deviation between the actual trigger point and the screen central line, which will be displayed as 0 at the center point of the screen.
- **Trigger level position:** It represents the voltage deviation between the actual trigger level and the zero position of the triggering signal source channel.

6.6 Recall factory settings

If you want to reset the Oscilloscope to the factory settings, do the following:

1. Press **MENU** key and the function menu appears on the right side of the screen
2. Press the **MENU ▲** or **MENU ▼** key to select **FUNCTION** setting and three options are visible at the bottom of the screen.
3. Press **F1** key to select “**Recall Factory**” to recall the factory settings.
4. Press **F2** key to select “Auto calibration”. If the ambient temperature variation is up to or larger than 5 Celsius degree, the Auto calibration function should be performed. But this will not affect the using and capability by the heat from LCD and electronic component

See the following figure 11:

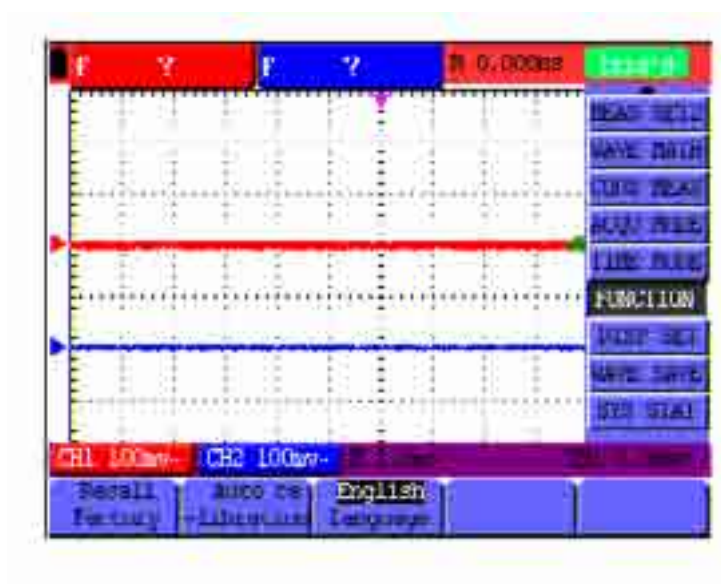

figure 11: Reset the Oscilloscope

6.7 Input Connections

See figure 2.

Look at the bottom and the right of the Oscilloscope. The Oscilloscope has six signal inputs: two safety BNC jack inputs (CH1 and CH2) for scope measurements, four safety 4-mm banana jack inputs for Multimeter R, V and A measurements.

Isolated input allows independent floating measurements between Multimeters and Scopes.

6.8 Displaying an Unknown Signal with Auto Set

The Auto-Set feature lets the Oscilloscope display and measure unknown signals automatically. This function optimizes the position, range, time base, and triggering and assures a stable display of virtually any waveform. This feature is especially useful for quickly checking several signals.

To enable the Auto-Set feature, do the following:

1. Connect the test probe to the tested signals.
2. Press the **AUTO SET** key and the Oscilloscope is under the automatic measurement condition. The tested signals appear on the screen.

6.9 Automatic Zero-returning of Trigger Horizontal Position and Trigger Level Position

When we adjust the trigger horizontal position and trigger level position to be maximal to make it off the screen center remotely, then we perform the following steps to make trigger horizontal position and trigger level position return to zero automatically.

1. Press **V** key, the trigger horizontal position automatically returns to zero.
2. Press **R** key, the trigger level position automatically returns to zero.

6.10 Automatic Measurements

The Oscilloscope offers 20 ranges of automatic scope measurements. You can display two numeric readings: **measurement 1** and **measurement 2**. These readings are selectable independently, and the measurements can be done on the input CH1 or input CH2 waveform.

To choose a frequency for CH1, do the following:

1. Press **MENU** key and the function menu appears on the right side of the screen.
2. Press **MENU ▲** or **MENU ▼** key to select **measurement 1**. Five items selectable are visible at the bottom of the screen.
3. Press **F1** key and select **Freq CH1** from the mean square root value item. The **measurement 1** window turns its color into red and shows the frequency for input CH1.

To choose a Peak-Peak measurement for Input CH2, do the following:

1. Press **MENU** key and the function menu are displayed on the right side of the screen.
2. Press **MENU ▲** or **MENU ▼** key and select **measurement 2**, with 5 items selectable displayed at the bottom of the screen.
3. Press **F4** key to select **PK-PK CH2** from Peak-Peak item. The **measurement 2** window turns its color to be blue and shows the peak-peak value for input CH2.

See the following figure 12:

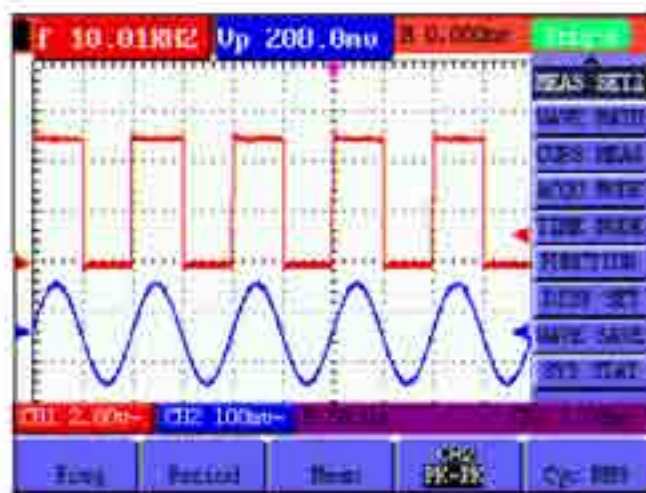

Figure 12: Automatic Scope Measurements

6.11 Freezing the Screen

You can freeze the screen (all readings and waveforms)

1. Press the **RUN/STOP** key to freeze the screen and **STOP** appears at top right side of the screen.
2. Press the **RUN/STOP** key once more to resume your measurement.

See the following figure 13:

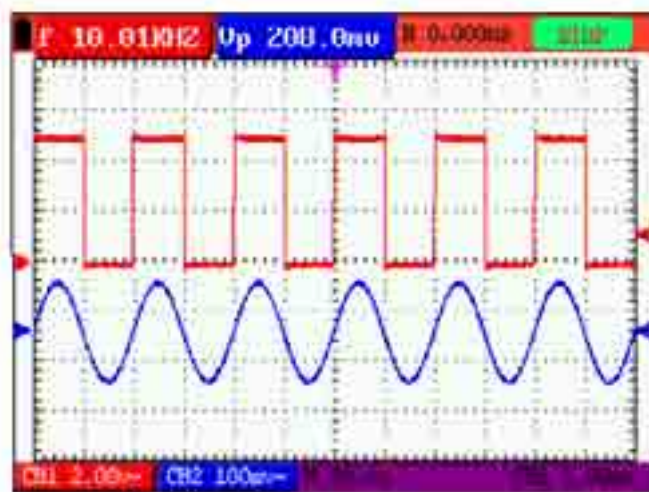

Figure 13: Freezing the Screen

6.12 Using Average for Smoothing Waveforms

Using the Average acquisition mode, you can smooth out the displayed waveform by averaging multiple data samples. The number of averaging is selectable from 4, 16, 64, and 128.

Note: In order for average mode to work in the best way, the waveform must be repetitive; As the number of averaging increases, the slower the waveform update becomes.

1. Press the **MENU** key and the function menu appears on the right side of the screen.
2. Press **MENU ▲** or **MENU ▼** key to select **ACQU** mode, with four items selectable displayed at the bottom of the screen.
3. Press the **F3** key to select **Average Factors**, then, press **F4** key to jump to **Averages 16** item. This averages the outcomes of 16 acquisitions and shows the final averaging result on the screen, shown as the following figures.

See the following figure 14:

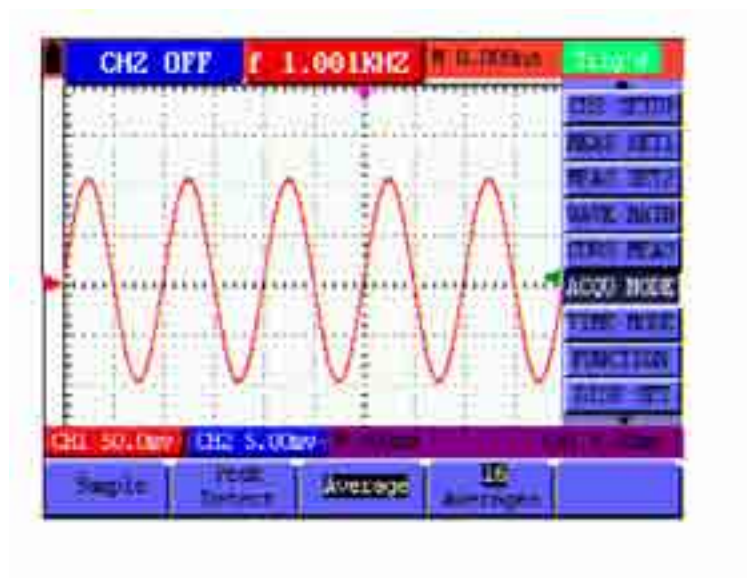

Figure 14: Average Factor Sampling Mode

6.13 Using Persistence to Display Waveforms

You can use Persistence to observe dynamic signals.

1. Press **MENU** key and the function menu appears on the right side of the screen.
2. Press **MENU ▲** or **MENU ▼** key to select **DISP SET**. Four items selectable are displayed at the bottom of the screen.
3. Press **F2** key to select **Persist 1 sec, 2 sec, and 5 sec, infinite or OFF**. In this case, jump to **Infinite** and the observed dynamic is kept on the screen continuously. When the item **OFF** is selected, the **Persistence** function is closed.

Look at the display, a screen like the following figure 15 can be shown.

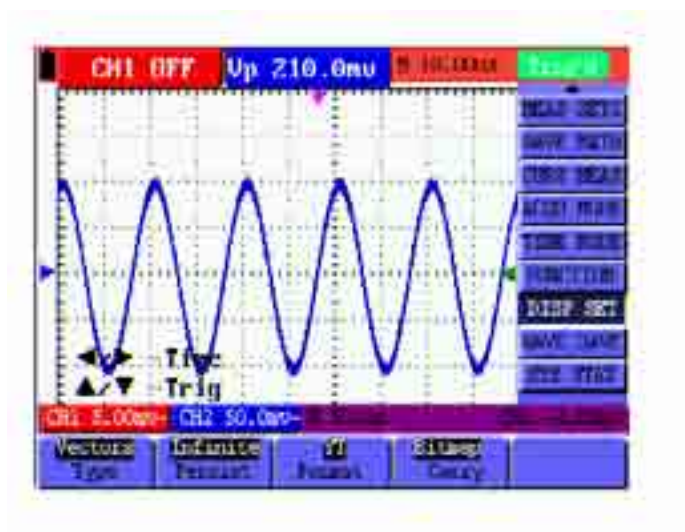

Figure 15: Persistence to Observe Dynamic Signals

6.14 Using Peak Detection to Display Glitches

You can use this function to display events (glitches or other asynchronous waveforms) of 50 ns or wider.

1. Press **MENU** key and the function menu appear at the right side of the screen.
2. Press **MENU ▲** or **MENU ▼** key to select the **ACQU MODE**. Four items selectable are displayed at the bottom of the screen.
3. Press **F2** key and jump to Peak Detect. In this case, you can test the glitch.

Now, you can see a screen that looks like the following figure 16.

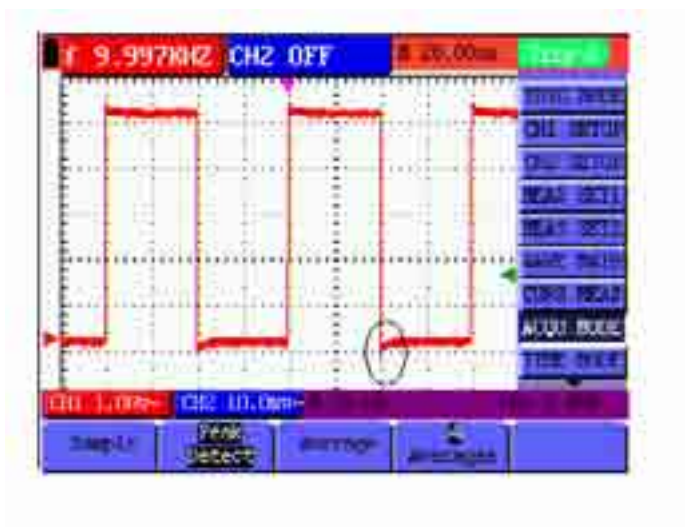

Figure 16: Peak Detection

Term interpretation

Collecting mode: The oscilloscope transforms the collected analog data into a digital form after they are gathered in the following three different modes, that is, sampling, peak value detection and averaging values.

Sampling: The oscilloscope takes samples from the signal at a equal time interval to reconstruct the waveform in this mode, by which the analog signal can be expressed correctly in most cases, yet, the rapid changes can not be collected between two sampling time intervals, causing the confusion and loss the narrow pulse in the signal probably.

Peak value detection: The oscilloscope takes samples from the maximum and minimum of signals in each sampling interval and shows the waveform with the sampled data in this mode, thus, by which the oscilloscope may collect the possibly lost narrow pulse in the sampling mode but the noise is obvious.

Averaging values: the oscilloscope collects several waveforms and average over them, and displays the averaged waveform in this mode, by which the random noise can be reduced.

Duration time: When a new waveform is displayed, the previous waveform shown on the screen does not disappear immediately only to be displayed for a period of time, that is, the duration time, by setting which, the waveform can be displayed more continuously and thus a display similar to that shown by the analog oscilloscope can be achieved.

Roll scan mode: The oscilloscope updates the waveform sampling points by scrolling display through a screen from left to right in this mode, which is only applicable to the primary time base setting of above 50ms.

6.15 Selecting AC-coupling

After a reset, the Oscilloscope is dc-coupled so that ac and dc voltages appear on the screen, Use ac-coupling when you wish to observe a small ac signal that rides on a dc signal. To select ac-coupling, do the following:

1. Press **MENU** key and the function menu appear at the right side of the screen.
2. Press **MENU ▲** or **MENU ▼** key to select the **CH1 Setting**. Four items selectable are visible at the bottom of the screen.
3. Press the **F1** key and jump to AC. The bottom left side of the screen displays the ac-coupling icon.

Now, you can see a screen that looks like the following figure 17.

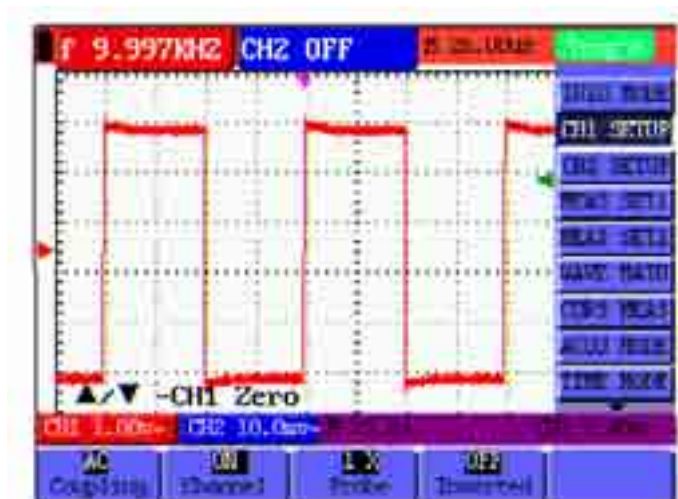

Figure 17: AC-Coupling

6.16 Reversing the Polarity of the Displayed Waveform

To invert the input CH1 waveform, do the following:

1. Press the **MENU** key and the function menu appears at the right side of the screen.
2. Press the **MENU ▲** or **MENU ▼** key to select CH1 setting. Four items selectable are displayed at the bottom of the screen.
3. Press **F4** key to jump to **Inverted**. The inverted waveform of CH1 is displayed on the screen.

Now, you can see a screen that looks like the following figure 18.



Figure 18: Inverted On

6.17 Using Waveform Mathematics Functions

When adding ($CH1 + CH2$), subtracting ($CH1 - CH2$, $CH2 - CH1$), multiplying ($CH1 * CH2$) or dividing ($CH1 / CH2$) the input waveforms of CH1 and CH2, the Oscilloscope will display the mathematical result waveform M and the input waveforms of CH1 and CH2 on the screen. The Mathematics functions perform a point-to-point calculation on the waveforms CH1 and CH2.

To use a Mathematics function, do the following:

1. Press the **MENU** key and the function menu is displayed at the right side of the screen.
2. Press the **MENU ▲** or **MENU ▼** key to select the **Waveform Calculation**. Five items selectable appears at the bottom of the screen.
3. Press **F3** key to select **CH1+CH2** and the calculated waveform M (green) appears on the screen. Again, press the **F3** key to close Waveform Calculation.

4. Press **OPTION** and left bottom display as

◀/▶ —CHMath Volts/Div

▲/▼ —CHM Zero

5. Then, press **▲** (yellow) or **▼** (yellow) to adjust vertical display position of waveform M.

Press **◀** (yellow) or **▶** (yellow) to adjust display times factor of waveform M.

Now, you can see a screen that looks like the following figure 19.

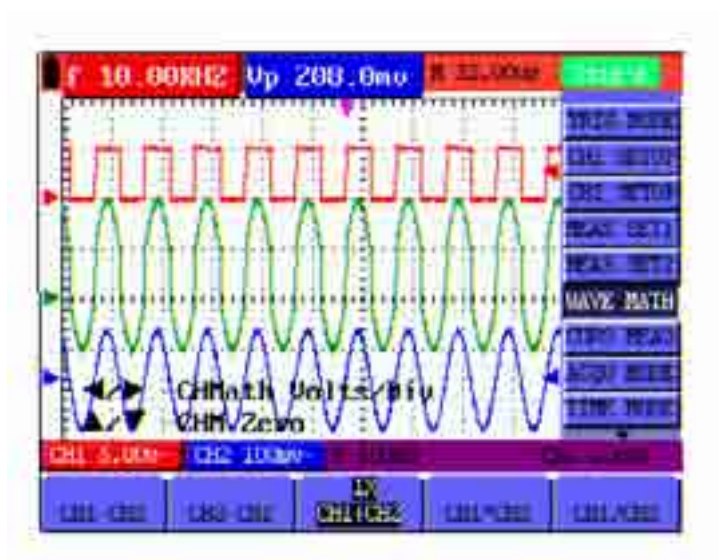

Figure 19: Waveform Mathematics

6.18 Use USB mass storage device to save waveform data

Insert the USB mass storage device into the USB port and press copy key, then the current waveform data will be saved into the USB mass. The save waveform has two format ,one is vector format and another is bitmap format, according to the display settings from the choice of the communication settings. Then the file name in sequence will be WAVE1.BIN、 WAVE2.BIN、 WAVE3.BIN.....or WAVE1.BMP、 WAVE2.BMP、 WAVE3.BMP..... Then connect the USB mass storage device with the computer after data is saved , and open the data of vector format . with OWON analysis software,or direct open the bitmap.

Note: It has clew,such as “waveform is saving”, “waveform has been saved”, “USB has been connected”, “USB has been off”,in a series of process USB operation storage.

7. Using the Multimeter

7.1 About this Chapter

This chapter provides a step-by-step introduction to the multi-meter functions of the test tool hereafter. The introduction gives basic examples to show how to use the menus and perform basic operations.

7.2 Making Meter Connections

Use the four 4-mm safety banana jack inputs for the Meter functions: **COM,V/ Ω /C,10A,mA**.

See figure 2 for the connections.

7.3 Multimeter Operation Window

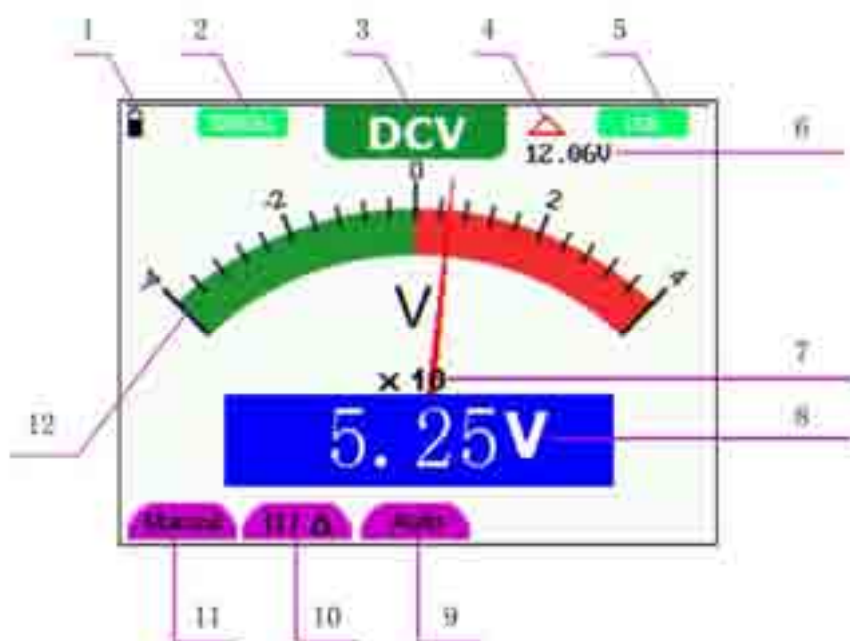

Figure 20: Multimeter Operation Window

Description

1. Battery electric quantity indicator.
2. Manual/Auto range indicators, among which the **MANUAL** means measuring range in manual operation mode and **AUTO** refers to the measuring range in automatic operation mode.

3. Measurement mode indicators:

DCV: Direct voltage measurement

ACV: Alternating voltage measurement

DCA: Direct current measurement

ACA: Alternating current measurement

R: Resistance measurement

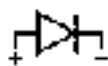

: Diode measurement



: On/Off measurement

C: Capacitance measurement

4. The relative magnitude measurement indicator.
5. Running state indicators, among which **RUN** expresses continuous update and **STOP** represents the screen locking.
6. The reference value of the relative magnitude measurement.
7. The multiplying power of the dial indication. To multiply the reading of dial pointer by multiplying power will get the measurement result.
8. The main reading of measurement
9. Automatic control measuring range.
10. Absolute/ relative magnitude measuring control: The sign “||” expresses the absolute magnitude measuring control and “△” represents the relative magnitude measuring control.
Manually measuring range control.
11. Manual measurement control.
12. Test lead indicated the scale of test reading; different test modes display different colors.

7.4 Making Multimeter Measurements

Press **DMM/OSC** key, the oscilloscope will switch to the multimeter measure, the screen will display the multimeter windows, at the same time, prompt to correctly insert testing pen of the multimeter, at this time, then press any key to enter into multimeter measure.

7.4.1 Measuring Resistance Values

To measure a resistance, do the following:

1. Press the **R** key and **R** appears at the top of the screen.

2. Insert the black lead into the **COM** banana jack input and the red lead into the **V/ Ω /C** banana jack input.
3. Connect the red and black test leads to the resistor. The resistor value readings are shown on the screen in Ohm.

Now, you can see a screen that looks like the following figure 21.



Figure 21: Resistance Measurement

7.4.2 Measuring Diode

To make a measurement on the diode, do the following:

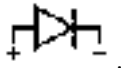
1. Press the **R** key and **R** appears at the top of the screen.
2. Press **SET** key till the following is displayed on the screen .
3. Insert the black lead into the **COM** banana jack input and the red lead into the **V/ Ω /C** banana jack input.
4. Connect the red and black leads to the resistor and the diode resistor readings are displayed on the screen in **V**.

Now, you can see a screen that looks like the following figure 22.



Figure 22: Diode Measurement

7.4.3 On-off Test

To perform an On-off test, do the following:

1. Press the **R** key and **R** appears on the top of the screen.
2. Press the **SET** key till the following is shown on the screen. 
3. Insert the black lead into the **COM** banana jack input and the red lead into the **V/Ω/C** banana jack input.
4. Connect the red and black leads to the test point. If the resistance value of the tested point is less than $50\ \Omega$, you will hear beep sound from the test tool.

Now, you can see a screen that looks like the following figure 23.



Figure 23: On-off Test

7.4.4 Measuring Capacitance

To measure a capacitance, do the following:

1. Press the **R** key and **R** appears on the top of the screen
2. Press the **SET** key till **C** appears at the top of the screen.
3. Insert the black leads to COM jack, and red leads to **V/ Ω /C jack**.
4. Connected the black and red leads with capacitance, then screen shows the capacitance reading.

Notice: when measured value is less than 5 nF capacitance, please use small capacitance measurer of this multimeter and use relative value measuring mode to improve measuring precision. It will take about 30seconds if capacitance measurement is larger than 40uF.

Now, you can see a screen that looks like the following figure 24.



Figure 24: Capacitance Measurement

7.4.5 Measuring DC Voltage

To measure a DC voltage, do the following:

1. Press the **V** key and **DCV** appears at the top of the screen.
2. Insert the black lead into the **COM** banana jack input and the red lead into the **V/ Ω /C** banana jack input.
3. Connect the red and black leads to the measured point and the measured point voltage value is displayed on the screen.

Now, you can see a screen that looks like the following figure 25.



Figure 25: DC Voltage Measurement

7.4.6 Measuring AC Voltage

To measure the AC voltage, do the following:

1. Press the **V** key and **DCV** appears at the top of the screen.
2. Press the **SET** key and **ACV** appears at the top of the screen.
3. Insert the black lead into the **COM** banana jack input and the red lead into the **V/ Ω /C** banana jack input.
4. Connect the red and black leads to the measured points and the AC voltage values of measured points will be displayed on the screen.

Look at the display; you can see a screen that looks like the following figure 26.



Figure 26: AC Voltage Measurement

7.4.7 Measuring DC Current

To measure a DC current which is less than 400 mA , do the following:

1. Press the **A** key and **DCA** appears at the top of the screen. The unit on the main reading screen is **mA**. **mA** and **10A** will display on the right bottom of screen, press **F4** or **F5** to switch the measurement between **mA** and **10A**. 400mA is acquiescently.
2. Insert the black lead into the **COM** banana jack input and the red lead into the **mA** banana jack input.
3. Connect the red and black leads to the measured points and the DC current values of measured points will be displayed on the screen.

Look at the display; you can see a screen that looks like the following figure 27.

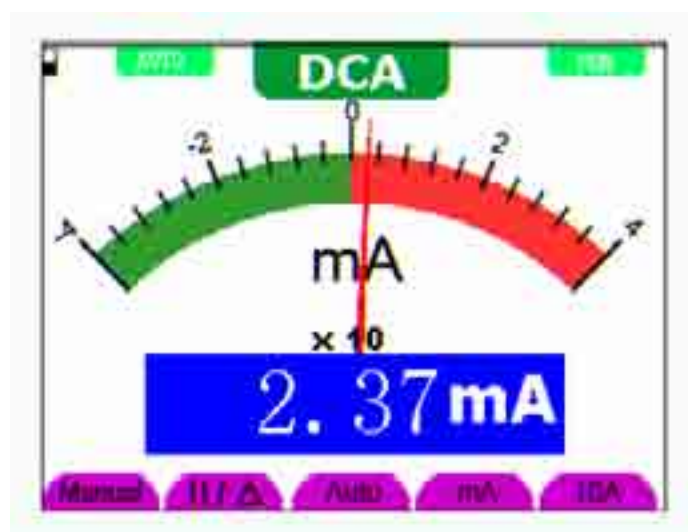

figure 27: DC Current Measurement for 400 mA

To measure a DC current which is larger than 400 mA, do the following:

1. Press the **A** key and **DCA** appears at the top of the screen. The unit on the main reading screen is **mA**.
2. Press **F5** key change to 10A measurement, the unit on the main reading screen is **A**.
3. Press the **SET** key once and **DCA** is visible at the top of the screen.
4. Connect the red and black leads to the measured point and the **DC** current value of the measured point will be displayed on the screen.
5. Press **F4** return to 400 mA measure.

Look at the display; you can see a screen that looks like the following figure 28.



figure 28: DC Current Measurement for 10A

7.4.8 Measuring AC Current

To measure an AC current which is less than 400 mA, do the following:

1. Press the **A** key and **DCA** appears at the top of the screen. The unit on the main reading screen is **mA**. **mA** and **10A** will display on the right bottom of screen, press F4 or F5 to switch the measurement between **mA** and **10A**. 400mA is acquiescently.
2. Press the **SET** key once and **ACA** is visible at the top of the screen.
3. Insert the black lead into the **COM** banana jack input and the red lead into the **mA** banana jack input.
4. Connect the red and black leads to the measured point and the **AC** current value of the measured point will be displayed on the screen.

Look at the display; you can see a screen that looks like the following figure 29.

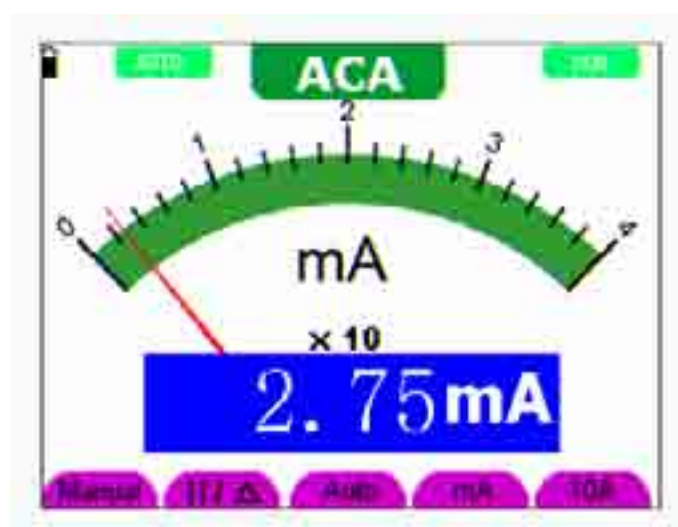

figure 29: AC Current Measurement for 400 mA

To measure an AC current which is larger than 400 mA, do the following:

1. Press the **SET** key once and **ACA** is visible at the top of the screen.
2. Press **F5** to select **10A** measure, the unit of main reading window is **A**.
3. Plug current extended module in current measure jack, then plug the probe in the module.
4. Connect the red and black leads to the measured point and the **AC** current value of the measured point will be displayed on the screen.
5. Press **F4** return to 400mA measure.

Look at the display; you can see a screen that looks like the following figure 30.



figure 30: AC Current Measurement for 10A

7.5 Freezing the Readings

You can freeze the displayed readings at any time.

1. Press the **RUN /STOP** key to freeze the screen and **STOP** will be displayed at the top right of the screen.
2. Again, press the **RUN /STOP** key, you can resume your measurement.

Look at the display; you can see a screen that looks like the following figure 31.



figure 31: Freezing the Readings

7.6 Taking a Relative Measurement

A currently measured result relative to the defined reference value is displayed in a relative measurement.

The following example shows how to take a relative measurement. At first, it is required to acquire a reference value.

1. Press **R** key and **R** is displayed on the top side of the screen.
2. Press the **SET** key till **C** appears at the top of the screen.
3. Plug capacitance extended module in capacitance measure jack.
4. When the reading leveling off, press **F2** key and Δ is displayed on the top side of the screen.
The saved reference value is displayed below Δ .
5. Plug capacitor, the displayed major reading on the screen is actual the capacitance value.

Look at the display; you can see a screen that looks like the following figure 32.



figure 32: Relative Measurement

7.7 Selecting Automatic/Manual Range Adjustment

The defaulted range mode of the instrument is automatic range. To switch to the manual range, perform the following steps:

1. Press **F1** key and **MANUAL** is displayed on the top left side of the screen to enter the manual range mode.
2. Under the manual range mode, the measuring range is increased by a stage when pressing **F1** key each time, and when reaching the highest stage, it jumps to the lowest stage by pressing **F1** key once again. To multiply the reading of dial pointer by multiplying power and the unit of main reading on the screen will get the measurement result.
3. Press **F3** key and **AUTO** is displayed on the top left side of the screen to switch back to the automatic range mode.

Look at the display; you can see a screen that looks like the following figure 33.



Figure 33: Automatic/Manual Range Adjustment

Attention: capacitance measurement without manual range mode.

8. Advanced Function of Oscilloscope

8.1 About this Chapter

This chapter will detail the oscilloscope function of the test tool.

8.2 Setting the Vertical CH1 and CH2

Each channel has its own independent vertical menu and each item can be set respectively based on the specific channel.

To make vertical CH1 and CH2 settings, do the following:

1. Press the **MENU** key and the function menu appears at the right of the screen.
2. Press the **MENU ▲** or **MENU ▼** key to jump to **CH1 SETUP** and 4 options appears at the bottom of the screen.
3. Select key from **F1** to **F4** to make different settings.

Now, you can find a screen that looks like the following figure 34.

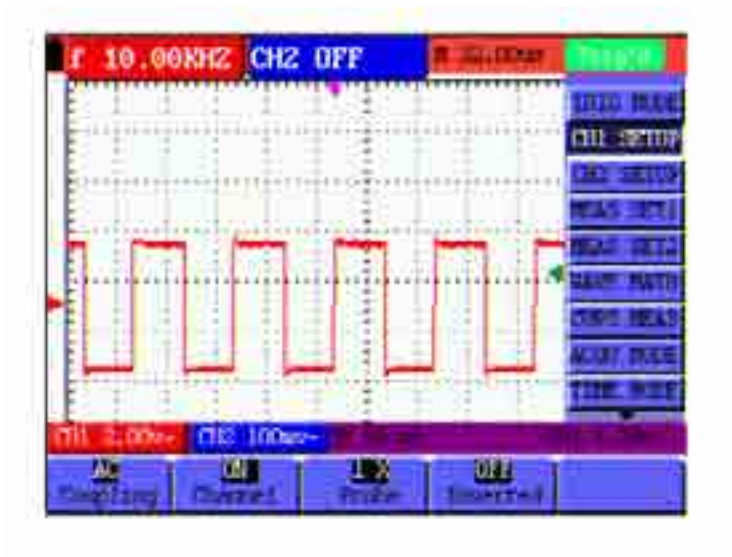

Figure 34: Setting the Vertical

The following Table describes the **Vertical Channel** menu:

Function menu	Setting	Description
Coupling	AC	The dc component in the input signal is blocked..
	DC	The ac and dc components of the input signal are allowed.
	GROUND	Input signal is interrupted.
Channel	OFF	Close the channel.
	ON	Open the channel.
Probe	1X	Select one according to the probe attenuation level to ensure a correct vertical scale reading.
	10X	
	100X	
	1000X	
Inverted	OFF	Waveform is displayed normally.
	ON	Open the Invert function of the waveform setting.

8.2.1 Setting the Channel Coupling

With CH1 taken for example.

Press **F1 Coupling** first and then **AC** to make an AC coupling setting. The DC component contained in the tested signal is blocked.

Press **F1 Coupling** first and then **DC** to make a DC coupling setting. Both DC and AC components contained in the tested signal are permitted.

Press **F1 Coupling** first and then **GROUND** to make a GROUND coupling setting. Input signal is interrupted.

The waveform is displayed as the following figure 35, figure 36, figure 37.

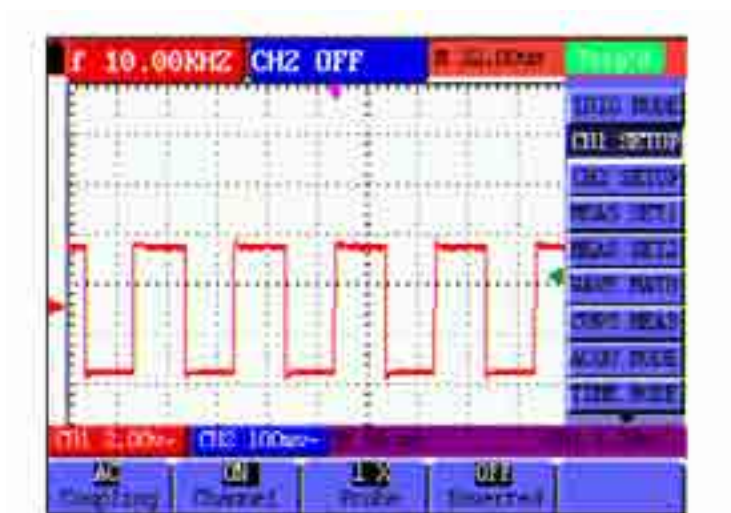

Figure 35: AC Coupling

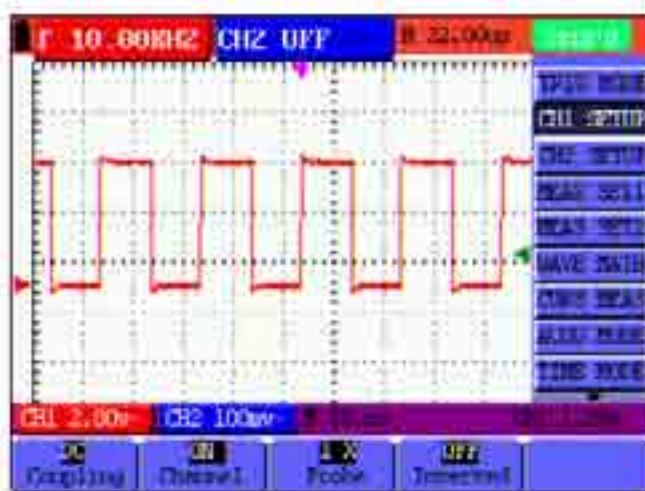

Figure 36: DC Coupling



Figure 37: Ground Coupling

8.2.2 Open and Close Settings on Channel

With CH1 taken for example.

Press **F2 Channel** key first, and then **OFF** to make a Close setting on CH1.

Press **F2 Channel** key first, and then **ON** to make an Open setting on CH1.

8.2.3 Setting the probe attenuation

To prevent excessive input voltage, we recommend you to set the probe attenuation level to the 10X position to prevent excessive voltage.

After attenuating the probe level by 10X, you also need to magnify the display level by 10X to match the displayed amplitude with the real amplitude.

Press **F3 Probe** to adjust the probe attenuation level.

Table: Probe attenuation level and the corresponding menu setting

Probe attenuation level	Corresponding Menu Setting
1:1	1X
10:1	10X
100:1	100X
1000:1	1000X

8.2.4 Setting of Inverted Waveform

Inverted waveform: The displayed signal reverses 180 degrees relatively to the ground potential.

Press **F4 Invert** to start Invert; press **F4 Invert** again to close Invert.

8.3 Make the Math Function Menu Setting

The **WAVE MATH** functions in showing the result of adding, subtracting, multiplying or dividing calculation on CH1 and CH2 channel waveforms. Also, the result of arithmetic operation can be measured with grid or cursor. The amplitude of the calculated waveform can be adjusted with **CHM VOL**, which is displayed in the scale factor form. The amplitude ranges from 0.001 through 10 and steps in the 1-2-5 form, that is, it can be expressed as 0.001X, 0.002X, 0.005X... 10X. The position of the calculated waveform can be adjusted up and down with the **CHM ZERO** key used.

The corresponding operation function table

Setting	Description
CH1-CH2	CH1 waveform minus CH2 waveform.
CH2-CH1	CH2 waveform minus CH1 waveform
CH1+CH2	Add CH1 waveform into CH2 waveform.
CH1*CH2	Multiply CH1 waveform and CH2 waveform.
CH1/CH2	Divide CH1 waveform by CH2 waveform

To perform the **CH1+CH2** waveform calculation, do the following:

1. Press the **MENU** key and the function menu appears at the right of the screen.
2. Press the **MENU ▲** or **MENU ▼** key to select **MATH** and 5 options are displayed at the bottom of the screen.
3. Press the **F3 CH1+CH2** key and the obtained waveform **M** appears on the screen. Again, press the **F3** key and Close the waveform **M**.
4. Press **OPTION** and left bottom display as

 CHMath Volts/Div

▲/▼ — CHM Zero

Press ◀(yellow) or ▶(yellow) to adjust the range of M waveform

Press ▲(yellow) or ▼(yellow) to adjust the position of M waveform

Now, look at the display and you will find a screen that looks like the following figure 38.

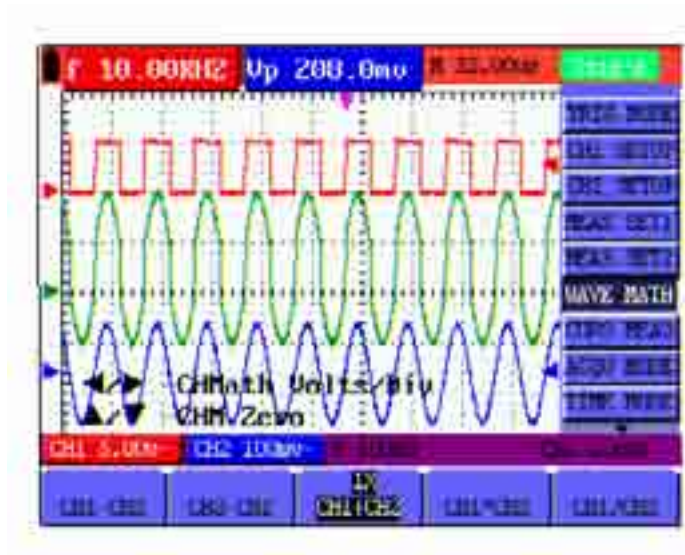

Figure 38: Waveform Mathematics

8.4 Setting the Trigger System

The Trigger defines the time when the acquisition of data and display of waveform. If it is set correctly, the trigger can turn an unstable display into a significant waveform.

When starting the acquisition of data, the oscilloscope collects sufficient data to draw the waveform at the left side of the triggering point. With waiting for the triggering condition, the oscilloscope is gathering data continuously. After a trigger is detected, the oscilloscope gathers enough data continuously to draw the waveform at the right side of the triggering point.

To make a trigger mode setting, do the following:

1. Press the **MENU** key and the function menu appears at the right of the screen.
2. Press the **MENU ▲** or **MENU ▼** key to select **TRIG MODE** and five options are displayed at the bottom of the screen.
3. Select from **F1 to F5** key to make a different setting.
4. Press **OPTION** and left bottom display as below during edge trigger and video trigger:

◀/▶ — Time

◀/▶ — Time Base

▲/▼ — Trig

▲/▼ — Trig

Left bottom display as below during alternate trigger:

◀/▶—Time Base ◀/▶ — Time
 ▲/▼—Trig1 ▲/▼ — Trig2

5. Press ▲ (yellow) or ▼ (yellow) to adjust trigger vertical position, Press ◀ (yellow) or ▶ (yellow) to adjust time base horizontal position or adjust horizontal position.

8.5 Triggering Control

There are three triggering modes including Edge triggering, Video triggering and Alternating triggering. Each trigger mode is set by different function menu.

Edge triggering: The edge trigger type triggers on the incoming signal edge. Use the edge trigger for all signals except for video related ones.

Video triggering: Perform video field trigger or line trigger on the standard video signals.

Alternate trigger: When the signal frequency different in Channel 1 and 2, it can also guarantee the stability approaching in two channels.

The following describes the Edge triggering, Video triggering and Alternating triggering menus respectively.

8.5.1 Edge Triggering

The Edge triggering is a mode by which trigger occurs at the triggering threshold value of the input signal edge. With the **Edge triggering** selected, the trigger happens on the rise or fall edge of the input signal, shown as the figure 39.

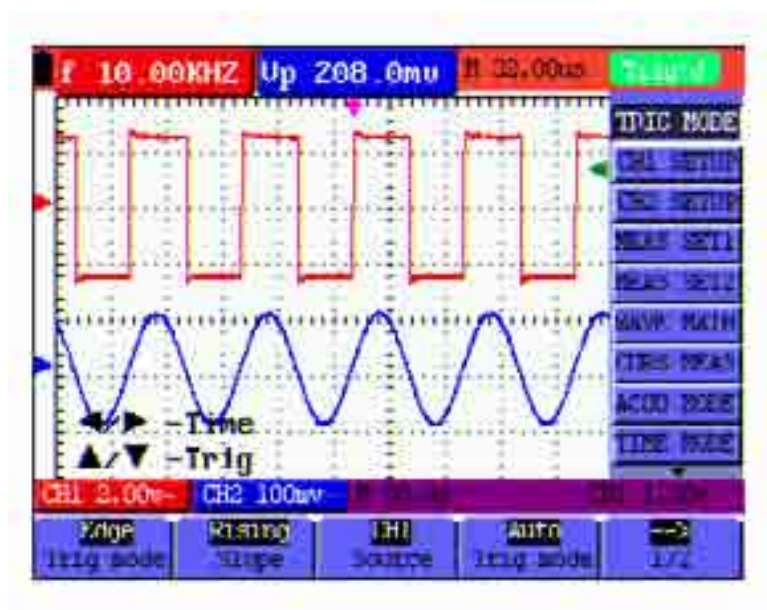



Figure 39: Edge Trigger

The **Edge triggering** menu is described in the following table.

Function menu	Settings	Description
Slope	Rising	Triggering on the rise edge of the signal.
	Falling	Triggering on the fall edge of the signal.
Source	CH1	CH1 is used as the trigger source.
	CH2	CH2 is used as the trigger source.
Trig mode	Auto	Acquisition of waveforms is possible even if there is no triggering condition detected.
	Normal	Acquisition of waveforms can only be done when the triggering condition is satisfied.
	Single	The sampling is performed on a waveform when one trigger is detected, then stop sampling.
		To next menu
Coupling	AC	With this mode selected, the DC component is prevented from passing-through.
	DC	All components are allowed.
	HF Rjc	The HF part of the signal is prohibited and only the LF component is allowed.
	LF Rjc	The LF part of the signal is prohibited and only the HF component is allowed.
SENS	0.2div~1.0div	Set trigger sensitivity, but HDS3102M-N is set at 0.3div
Holdoff		To go to holdoff menu
		Back to previous menu

Term interpretation

Sensitivity: Trigger circuit including sluggish in order to exclude the influences from signal noise and get the stable trigger. The sluggish is adjustable among 0.2div~1.0div. It means when set on 1.0 div trigger circuit doesn't have any response to any signal of PK-PK range ≤ 1.0 div which to exclude the influences from signal noise.

8.5.2 Video Triggering

The video trigger type is designed to capture the video signal format, **NTSC**, **PAL** or **SECAM**. For any other signal type, use the edge trigger.

Figure 40,figure 41 is the Video Odd Field Trigger, figure 42,figure 43 is the Video Line trigger.

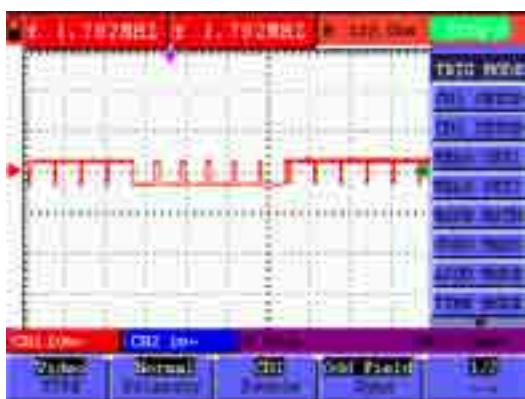

figure 40: Video Odd Field Trigger (Page1)

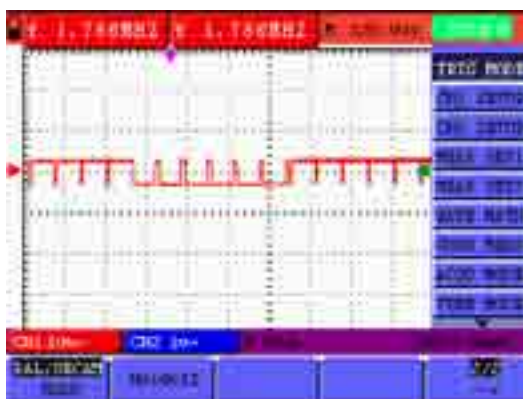

figure 41: Video Odd Field Trigger (Page2)

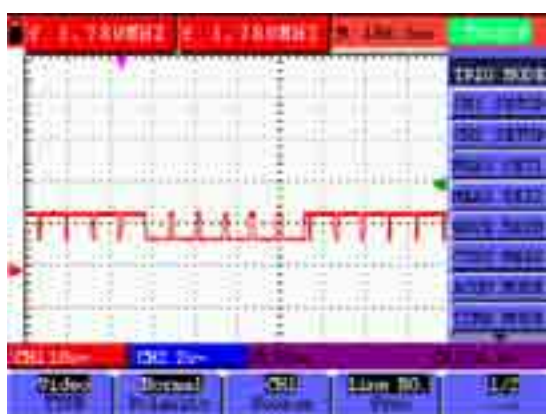

figure 42: Video Designed Line trigger(Page1)

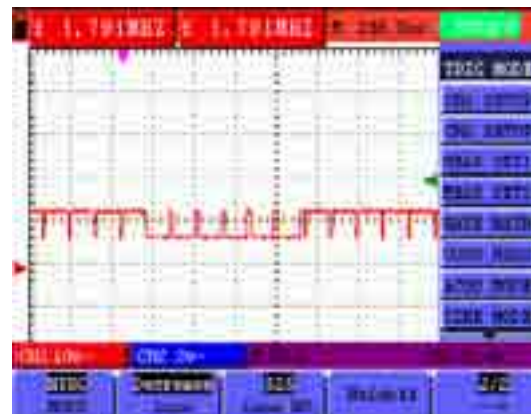



figure 43: Video Designed Line trigger(Page2)

The Video triggering menu is described in the following table(First page):

Function menu	Settings	Description
Polarity	Normal	Applicable to the video signal in which the black level is of low level.
	Inverted	Applicable to the video signal of which the black level is of high level.
Source	CH1	Select CH1 as the trigger source.
	CH2	Select CH2 as the trigger source..
Sync	Line	Make a video line trigger synchronization setting.
	Field	Make a video field trigger synchronization setting.
	Odd Field	Make a video odd field trigger synchronization setting.
	Even Field	Make a video even field trigger synchronization setting.
	Designed Line	Make a video designed line synchronization setting.
		To next menu

The Video triggering menu (Second page):

1. when the sync is Line,Field,Odd Field,Even Field,the second page menu is shown as bellow.

MODU	NTSC PAL/SECAM	Video format setting
Holdoff		To go to holdoff menu
		Back to previous menu

2. when the sync is Designed Line,the second page menu is shown as bellow.

MODU	NTSC PAL/SECAM	Video format setting
Line	increase decrease	Set the line value to increase Set the line value to decrease
Line No.		Set and Show the line valve
Holdoff		To go to holdoff menu
		Back to previous menu

8.5. 3 Alternate trigger

During alternate trigger, the trigger signal mainly comes from two vertical channels and it can be used to observe two irrelevant signals. You can set different trigger type for two vertical channels in this menu (optional for edge trigger and video trigger).

Now, you can see a screen that looks like the figure 44.

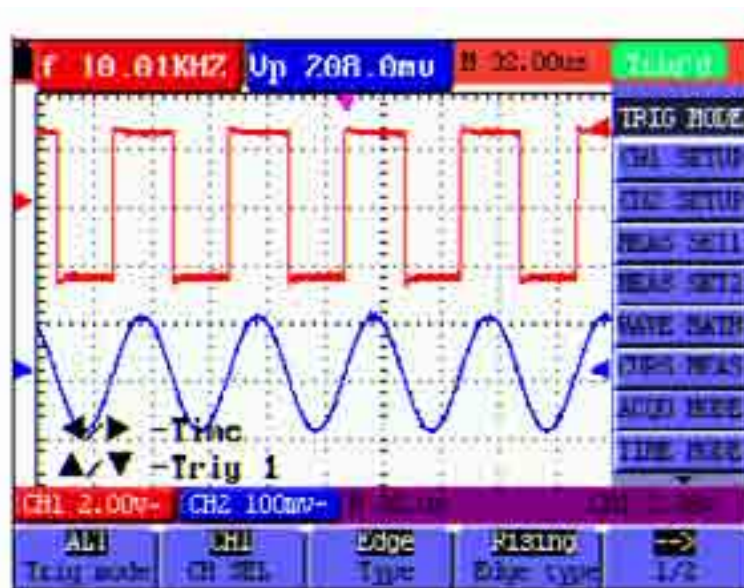



Figure 44 Alternate Trigger

The Alternate triggering menu is described in the following table.

When the type is setted as **Edge trigger**,

Function menu	Settings	Description
CH SEL	CH1	Setting trigger type and others info for Channel 1
	CH2	Setting trigger type and others info for Channel 2
Type	Edge	Set vertical channel trigger as edge trigger
	Video	Set vertical channel trigger as video trigger
Edge type	Rising	Triggering on the rise edge of the signal.
	Falling	Triggering on the fall edge of the signal.
		To next menu
Coupling	AC	With this mode selected, the DC component is prevented from passing-through.
	DC	All components are allowed.
	HF Rjc	The HF part of the signal is prohibited and only the LF component is allowed.
	LF Rjc	The LF part of the signal is prohibited and only the HF component is allowed.
SENS	0.2div~1.0div	Set trigger sensitivity(Note: HDS3102M-N is set at 0.3div)
Holdoff		To go to holdoff menu
		Back to previous menu

When the type is setted as **video type**,

Function menu	Settings	Description
CH SEL	CH1	Setting trigger type and others info for Channel 1.
	CH2	Setting trigger type and others info for Channel 2.
Type	Edge	Set vertical channel trigger as edge trigger.
	Video	Set vertical channel trigger as video trigger
Video type Polarity	Normal	Applicable to the video signal of which the black level is low.
	Inverted	Applicable to the video signal of which the black level is high.
Sync (Synchronization)	Line	Set synchronous trigger in video line.
	Field	Set synchronous trigger in video field.
	Odd field	Set synchronous trigger in video odd line.
	Even field	Set synchronous trigger in video even line.
	Line NUM	Set synchronous trigger in video Line NUM

when the sync is Line,Field,Odd Field,Even Field,the following menu is shown as below:

MODU (Modulation)	NTSC PAL/SECAM	Set synchronization and account choose video standard Set synchronization and account choose video standard
Holdoff		To go to holdoff menu.
when the sync is Designed Line,the following menu is shown as below:		
MODU (Modulation)	NTSC PAL/SECAM	Set synchronization and account choose video standard Set synchronization and account choose video standard
Line	increase	Set the line value to increase.
	decrease	Set the line value to decrease.
Line No.		Set and Show the line valve.
Holdoff		To go to holdoff menu.

When you go to the holdoff menu,you can see a screen in the following figure45.

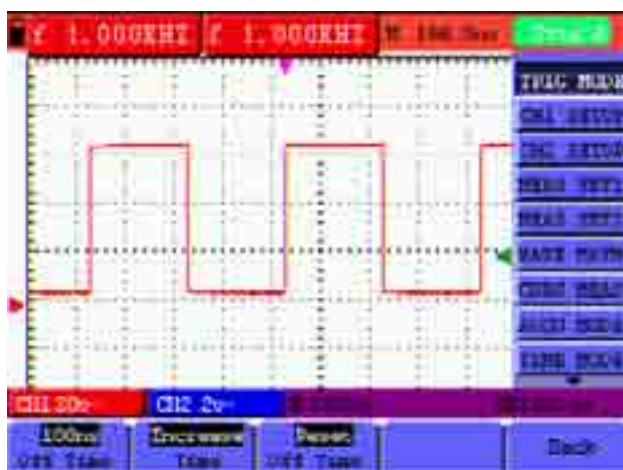

figure45:Trigger Holdoff

the **Holdoff** menu is described in the following table:

Function menu	Settings	Description
Off Time		Set time slot before another trigger event.
Time	increase	Set the off time to increase.
	decrease	Set the off time to decrease.
Reset Off Time		Reset Holdoff time to 100ns.
Back		Back to previous menu.

Note:

Trigger Holdoff can stabilize complex waveform,such as the pulse range.Holdoff time is the oscilloscope’s waiting period before starting a new trigger.During Holdoff,oscilloscope will not trigger until Holdoff ends.

Term interpretation

Holdoff: Set time slot before another trigger event.

Trigger modes: There are three kinds of trigger modes available for this oscilloscope, they are, Auto (acquires signal continuously), Normal (acquires signal when trigger conditions are met) and Single (manually triggers the signal).

Automatic trigger mode: The oscilloscope can acquire the waveform without any triggering condition detected in this mode, in which it will be triggered compulsively when waiting for a specified period of time without any triggering condition ignited. When an invalid trigger is enforced, the oscilloscope can not keep the waveform in phase.

Normal trigger mode: In this mode, the oscilloscope cannot acquire the waveform till it is triggered. When there is not any trigger, the oscilloscope will display the original waveform without new waveforms captured.

Single mode: In this mode, the oscilloscope will detect a trigger and capture a waveform at each time when the customer presses the RUN/STOP key.

8.6 Selecting the acquisition mode

The **Acquiring Mode** menu is described in the list shown as below.

Function menu	Settings	Description
Sample		The waveform data is sampled at an equal time interval. The sample mode accurately reconstructs the waveform, but cannot respond to rapid changes and sudden peaks.
Peak Detect		The maximum and minimum data in the sampling interval are picked up. The peak detect mode captures rapid changes and sudden peaks, but the waveform becomes noisy.
Average		Multiple samples are averaged together. The average mode reduces the noise level, but the waveform must be repetitive.
Averages	4, 16, 64 or 128	Select the average number.

8.7 Display Setting

The **Display Setting** menu is described in the following table.

Function menu	Settings	Description
Type	Vectors	The vector drawing mode shows the waveform as a smooth line, connecting each data point.
	Dots	The dot drawing mode shows the waveform as a collection of independent data points.
Persist	OFF 1s 2s 5s Infinite	The persistence setting sets how long the old waveforms remain in the display, useful for observing the waveform variations.
Format	YT	Display the relative relationship between vertical voltage and horizontal time.
	XY	Display CH1 on the horizontal axis and CH2 on the vertical axis.
Carry	Bitmap	The data transmitted in communication are bitmaps.
	Vectors	The data transmitted in communication are vectors.
Cymometer	ON	to set up cymometer limit to "ON" status.
	OFF	to set up cymometer limit to "OFF" status.

Note:Cymometer function is only for the HDS2062M-N and HDS3102M-N.

8.7.1 Display Style

The display style includes **Vector** and **Dot** displays, shown as the following figure 46, figure 47.

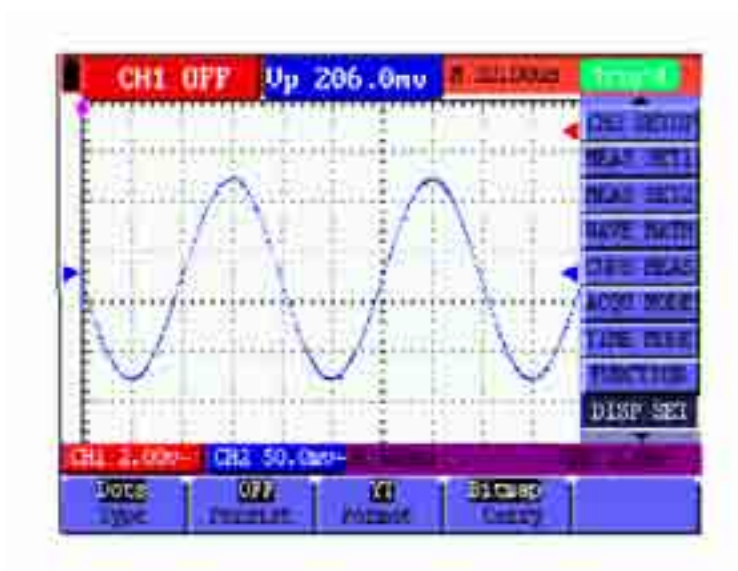

Figure 46: Dot Style



Figure 47: Vector Style

8.7.2 Persistence

With **Persistence** function selected, the displayed saved original data gradually decay in color and the new data are bright in color; with infinite persistence mode selected, the oscilloscope keeps all past traces of the displayed waveform.

8.7.3 XY Mode

This mode is only applicable to CH1 and CH2. The X-Y format plots the CH1 input as X-axis and CH2 input as Y-axis. This display mode is convenient for viewing the phase relationship between CH1 and CH2; when the oscilloscope is under the sampling mode in which no trigger is found, the data appear in light spots.

Operations for various control keys are shown as below:

- The **CH1 VOL** and **CH1 ZERO** for CH1 are used to set the horizontal scale and position.
- The **CH2 VOL** and **CH2 ZERO** for CH2 are used to set the vertical scale and position continuously.

The following functions do not work in the XY display mode:

- Reference or digital value waveform
- Cursor
- Time base control
- Trigger control

8.7.4 Cymometer(Only for the HDS2062M-N and HDS3102M-N)

It is a 6 digits cymometer. Its measurement range of frequency is 2Hz to full bandwidth.

Set up cymometer limit to “ON” status,

when the triggering mode is edge triggering, it is a one channel cymometer and it can only measure the frequency of the triggering channel.

When the triggering mode is alternating triggering, it is a two channel cymometer and it can measure the frequency of two channels.

To make a cymometer setting, do the following:

If you want to measure frequency of the two Channels, you can do as the follows:

1. Press **MENU**, the function menu will appear on the right of the screen.
2. Press **MENU ▲** or **MENU ▼** and choose Display Setting, five options will show at the bottom of the screen.
3. Press **F5** and choose ON.

See the following figure 48:

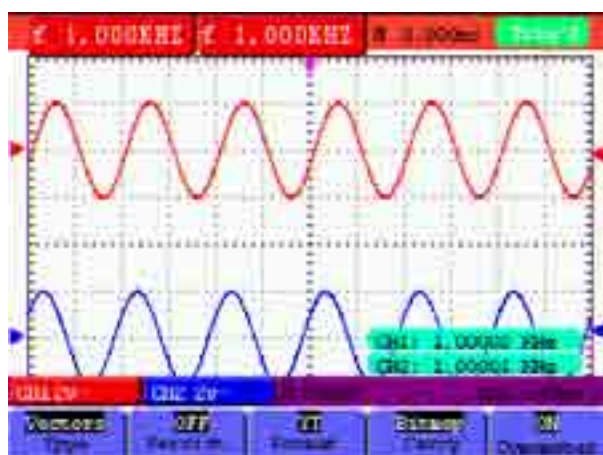

Figure 48

8.8 Waveform Saving Setups

The oscilloscope can save 4 waveforms, which can be displayed on the screen with the present waveform. The recalled waveform saved in the memory cannot be adjusted.

8.8.1 Waveform Saving Setups in normal mode

The **waveform saving /recalling menu** is described in the following list.

Function menu	Setups	Description
Source	CH1 CH2 MATH	Make sure the waveform you want to save appears in the display. Select the displayed waveform which you want to save.
WAVE	A, B, C and D	Select the address for saving or recalling a waveform.
Save		Store the waveform of a selected signal source into the selected address.
Show	ON OFF	Close or start displaying the waveforms stored in address A, B, C or D.

To save a waveform on CH1 in address A, do the following:

1. Press the **MENU** key and the function menu appears at the right of the screen.
2. Press the **MENU ▲** or **MENU ▼** key to select the **WAVE SAVE**. Four options are displayed at the bottom of the screen.
3. Press the **F1** key to select the signal source CH1.
4. Press the **F2** key to select the address A.
5. Press the **F3** key to save the waveform on CH1 in address A.

To display the saved waveform on the screen, do the following:

6. Press the **F4** key to select Start for the address A. The waveform saved in address A will be displayed on the screen in green color.

The display color is green, and the zero point of waveform, voltage and time is purple

Now, you can see a screen that looks like the following figure 49.

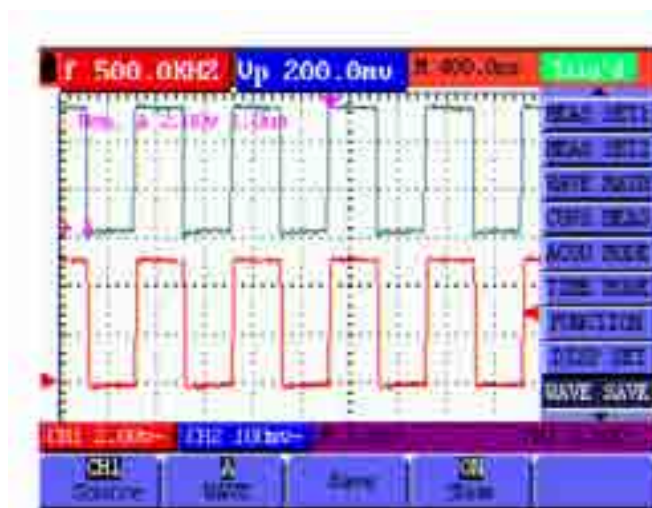

Figure 49: Waveform Saving

8.8.2 Waveform Saving Setups in FFT mode

FFT being on, the **waveform saving /recalling menu** is described in the following list.

Function menu	Setups	Description
Source	CH1 OFF CH2 OFF FFT	Only FFT waveform you can to save appears in the display.
WAVE	A, B, C and D	Select the address for saving or recalling a waveform.
Save		Store the waveform of a selected signal source into the selected address.
Show	ON OFF	Close or start displaying the waveforms stored in address A, B, C or D.

To save a waveform on CH1 in address A, do the following:

1. Press the **MENU** key and the function menu appears at the right of the screen.
2. Press the **MENU ▲** or **MENU ▼** key to select the Waveform Saving. Four options are displayed at the bottom of the screen.
3. Press the **F1** key to select **FFT**.
4. Press the **F2** key to select the address **A**.
5. Press the **F3** key to save the waveform on CH1 in address A

To display the saved waveform on the screen, do the following:

6. Press the **F4** key to select Start for the address A. The waveform saved in address A will be displayed on the screen in green color and the zero point of waveform, Vamp and Freq is purple.

Now, you can see a screen that looks like the following figure50

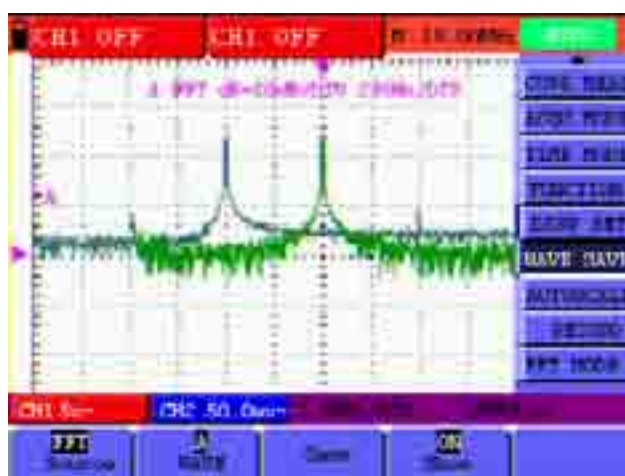

Figure 50

8.9 Function Setting Menu

The **function** menu is described in the following list.

Function menu	Setting	Description
Recall Factory		Resume the instrument to its factory settings.
Auto Calibration		Perform the Auto-calibration procedure.
Language	Chinese English	Select the display language.

Auto-calibration

The Auto-calibration function automatically configures internal parameters to maintain the sensitivity and accuracy. Run the Auto-calibration in the following cases:

When the temperature fluctuates more than 5 degrees Celsius during operations.



When operating the oscilloscope in a new bench top or field environment.

Procedure:







1. Press the MENU key and select the **FUNCTION** menu using **MENU ▲** or **MENU ▼** key.
2. Press F2 (Auto calibration). A message appears on the display, asking you to remove all cables and probes from oscilloscope.
3. After removing all cables, press F2 (Auto calibration) again. The Auto-calibration automatically starts and a message appears, showing that the calibration is ongoing.

To interrupt calibration, press any key during the calibration.

8.10 Making Automatic Measurements

The oscilloscope can perform 20 types automatic measurements such as frequency, cycle, average value, peak-to-peak value, root mean square value, Vmax, Vmin, Vtop, Vbase, Vamp, Overshoot, Preshoot, RiseTime, Fall Time, +Width, -Width, +Duty, -Duty, DelayA- and DelayA-. And gives two kinds of measurement results simultaneously on the screen.

The function menu for automatic measurements is described in the following list.

Function menu	Settings	Description
Freq	CH1	Measure the frequency of CH1.
	CH2	Measure the frequency of CH2.
Period	CH1	Measure the period of CH1.
	CH2	Measure the period of CH2.
Mean	CH1	Measure the average value of CH1.
	CH2	Measure the average value of CH2.
Peak-Peak	CH1	Measure the peak-to-peak value of CH1.
	CH2	Measure the peak-to-peak value of CH2.
Cyc RMS	CH1	Measure Root Mean Square (RMS) value of CH1.
	CH2	Measure Root Mean Square (RMS) value of CH2.
V _{max}	CH1	Measure the V _{max} of CH1
	CH2	Measure the V _{max} of CH2
V _{min}	CH1	Measure the V _{min} of CH1
	CH2	Measure the V _{min} of CH2
V _{top}	CH1	Measure the V _{top} of CH1
	CH2	Measure the V _{top} of CH2
V _{base}	CH1	Measure the V _{base} of CH1
	CH2	Measure the V _{base} of CH2
V _{vamp}	CH1	Measure the V _{vamp} of CH1
	CH2	Measure the V _{vamp} of CH2
Overshoot	CH1	Measure the Overshoot of CH1
	CH2	Measure the Overshoot of CH2
Preshoot	CH1	Measure the Preshoot of CH1
	CH2	Measure the Preshoot of CH2
RiseTime	CH1	Measure the RiseTime of CH1
	CH2	Measure the RiseTime of CH2
Fall Time	CH1	Measure the Fall Time of CH1
	CH2	Measure the Fall Time of CH2
+Width	CH1	Measure the +Width of CH1
	CH2	Measure the +Width of CH2
-Width	CH1	Measure the -Width of CH1
	CH2	Measure the -Width of CH2
+Duty	CH1	Measure the +Duty of CH1
	CH2	Measure the +Duty of CH2
-Duty	CH1	Measure the -Duty of CH1
	CH2	Measure the -Duty of CH2
DelayA- 	CH1	Measure the DelayA-  of CH1
	CH2	Measure the DelayA-  of CH2
DelayA- 	CH1	Measure the DelayA-  of CH1
	CH2	Measure the DelayA-  of CH2

To measure the frequency of CH1 with **Measurement 1** and the peak-to-peak value of CH2 with **Measurement 2**, do the following:

1. Press the **MENU** key and the function menu is shown at the right of the screen.
2. Press the **MENU ▲** or **MENU ▼** key to select **MEAS SET 1**. Five options appear at the bottom of the screen.
3. Press the **F1** key to select the frequency measurement as **CH1**. The measurement window on the screen turns into one red in color and shows the frequency of CH1.
4. Press the **MENU ▲** or **MENU ▼** key to select **MEAS SET 2**. Five options appear at the bottom of the screen.
5. Press the **F4** key to jump to the peak-to-peak measurement as **CH2**. The measurement window on the screen turns into one blue in color and shows the peak-to-peak value of CH2.

Now, you can see a screen that looks like the following figure 51.

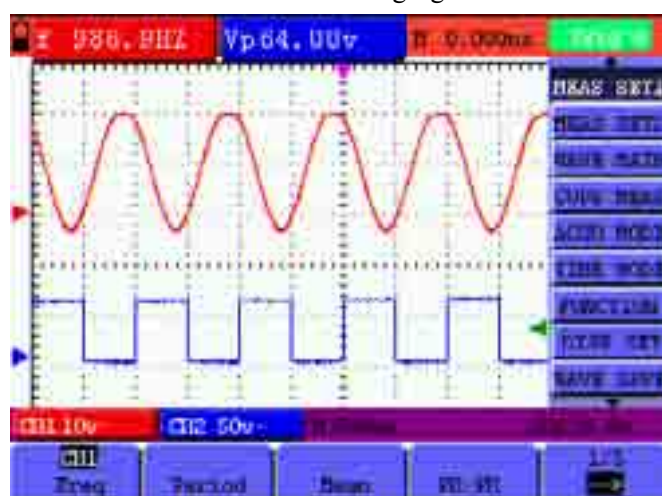

Figure 51: Automatic Measurements

8.11 Setting the Cursor Measurements

This oscilloscope allows you to make manual cursor measurements on time and voltage. The signal sources include Channel 1(CH1), Channel 2 (CH2).

8.11.1 Setting the cursor measurement in normal mode

The cursor measurement menus are listed and described in the following table.

Function menus	Settings	Description
Type	OFF	Close the cursor measurement.
	Voltage	Display the voltage measurement cursor and menu.
	Time	Display the time measurement cursor and menu.
Source	CH1, CH2.	Select the waveform channel on which the cursor measurement will be performed.

Delta		Display the difference of measured value between the two channels
Cur1		Display the relating measured value of Cursor 1
Cur2		Display the relating measured value of Cursor 2

To make a voltage measurement on CH1, doing the following:

1. Press the **MENU** key and the function menus are displayed at the right of the screen.
2. Press the **MENU ▲** or **MENU ▼** key to select **Cursor Measurement**. Five options are shown at the bottom of the screen.
3. Press F1 key to select the measurement type Voltage. Two purple crossing dashed lines V1 and V2 are shown on the screen.
4. Press the **F2** key to select the measured channel **CH1**.
5. Press **OPTION** and display as

◀/▶—Cursor 2

▲/▼—Cursor 1

When setting **OPTION ▲** or **OPTION ▼**, V2 will move up and down and the relating voltage value to the zero position of Channel 1 will show at the bottom of the screen. Setting **OPTION ◀** or **OPTION ▶**, V1 will move up and down and the relating voltage value to the zero position of Channel 1 will show at the bottom of the screen, at the same time the increment shows the absolute value of V1-V2 shown as Fig 52:



Figure 52 : Use the Cursor for a Voltage Measurement

When log out submenu, every value will show on the right bottom of the screen as

figure 53:

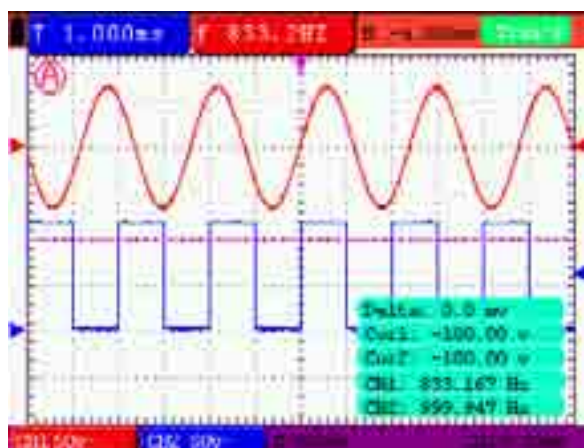

Figure 53

To use the cursor for a time measurement on CH1, do the following:

1. Press the **MENU** key and the function menus are displayed at the right of the screen.
2. Press the **MENU ▲** or **MENU ▼** key to select **Cursor measurement** key. Five options are shown at the bottom of the screen.
3. Press the **F1** key to the measurement type **Time**. Two vertical dashed lines T1 and T2 appear on the screen.
4. Press the **F2** key and jump to the measured channel CH1.
5. Press **OPTION** and display as

◀/▶—Cursor 2

▲/▼—Cursor 1

Press ▲(yellow) or ▼(yellow) and see T1 move left and right and LCD display the time value match T1 to point position in panel; press ▶(yellow) or ◀(yellow) and see T2 move left and right and LCD display the time value match T2 to point position in panel.

Now, you can see a screen that looks like the following figure 54.

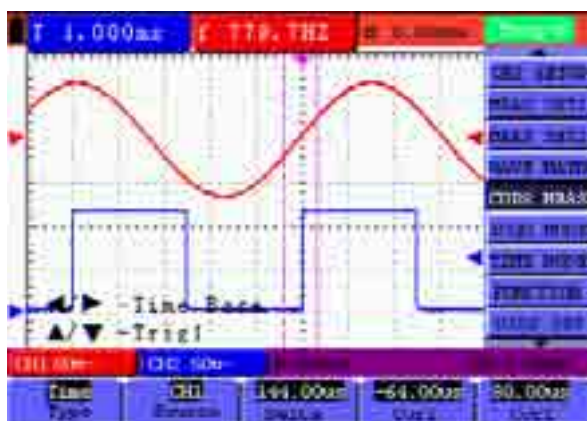

Figure 54: Cursor time measurement

When log out submenu, every value will show on the right bottom of the screen as figure 55:

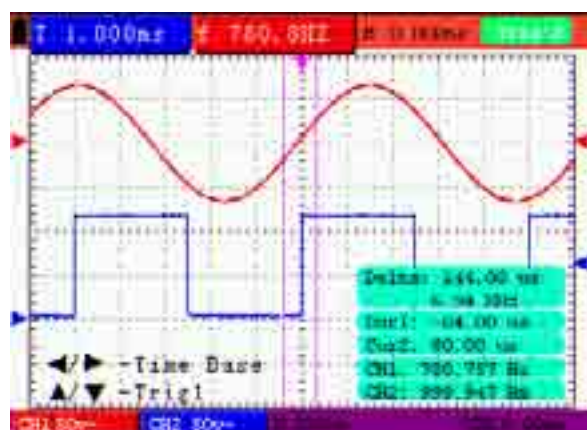

Figure 55: Use the Cursor for a Time Measurement

8.11.2 Setting the cursor measurement in FFT mode

FFT being on, the cursor measurement menus are listed and described in the following table.

Function menus	Settings	Description
Type	OFF	Close the cursor measurement.
	Range	Display the vamp measurement cursor and menu.
	Frequency	Display the freq measurement cursor and menu.
Source	CH1, CH2	Select the waveform channel on which the cursor measurement will be performed.
Delta		Display the difference of measured value between the two channels
Cur1		Display the relating measured value of Cursor 1
Cur2		Display the relating measured value of Cursor 2

To make a range measurement on CH1, doing the following:

1. Press the **MENU** key and the function menus are displayed at the right of the screen.
2. Press the **MENU ▲** or **MENU ▼** key to select **Cursor Measurement**. Five options are shown at the bottom of the screen.
3. Press F1 key to select the measurement type **Range**. Two purple crossing dashed lines V1 and V2 are shown on the screen.
4. The channel which FFT operates is the measured channel **CH1**.
5. Press **OPTION** and display as

◀/▶ —Cursor 1

▲/▼ —Cursor 2

Press ▲(yellow) or ▼(yellow) to see V1 move up and down and the panel will display the voltage value match V1 and Channel 1 Zero; Press ◀(yellow) or ▶(yellow) to see V2 move up and down and panel will display the voltage value match V2 to Channel 1 Zero. LCD panel also display the absolute value of V1-V2.

Now, you can see a screen that looks like the following figure 56.





Figure 56:Cursor range measurement

8.12 Autoscale

The function is applied to follow-up signals automatically even if the signals change at any time. Autoscale enables the instrument to set up trigger mode, voltage division and time scale automatically according to the type, amplitude and frequency of the signals.

The menu is as follows:

Function menus	Settings	Description
Autoscale	OFF	Turn off Autoscale
	ON	Turn on Autoscale
Mode	Vertical	Follow-up and adjust vertical scale without changing horizontal setting
	Horizontal	Follow-up and adjust horizontal scale without changing vertical setting
	HORI—VERT	Follow-up and adjust the vertical and horizontal settings.
		Only show one or two periods
		Show Multi-period waveforms

If you want to measure voltage of Channel 1, you can do as the follows:

1. Press **MENU**, the function menu will appear on the right of the screen.
2. Press **MENU ▲** or **MENU ▼** and choose Autoscale, three options will show at the bottom of the screen.
3. Press **F1** and choose **ON**.
4. Press **AUTOSET**

Pressing **AUTOSET** to enter into Autoscale function and  flicker on the top left corner. (flicker every 0.5 second)

If the Autoscale function is off, pressing **AUTOSET** is just to enter into **AUTOSCALE** function.

5. Press **F2** and choose **Hori- Vert**.
6. Press **F3** and  displays on the screen as figure 57:

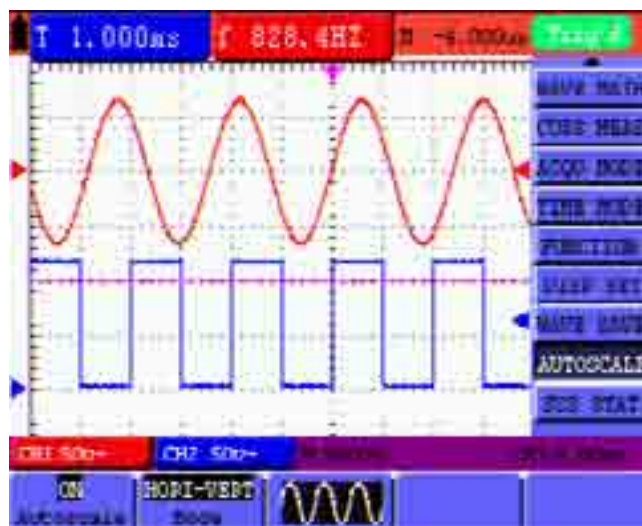



Figure 57: Autoscale Horizontal- Vertical multi-period waveforms

Note:

1. Entering into Autoscale function and  flicker will be on the top left corner. (flicker every 0.5 second)
2. At the mode of Autoscale, the oscilloscope can self-estimate “Trigger mode” (Edge, Video, and Alternate) and “Type” (Edge, Video). If now, you press “Trigger mode” or “Type”, the forbidden information will display on the screen.
3. At the mode of XY and STOP status, pressing **AUTO SET** to enter into Autoscale, DSO switches to YT mode and AUTO status.
4. At the mode of Autoscale, DSO is always in the state of DC coupling and AUTO triggering. In this case, the forbidden information will be showing when making Triggering or Coupling settings.
5. At the mode of Autoscale, if adjust the vertical position, voltage division, trigger level or time scale of CH1 or CH2, the oscilloscope will turn off Autoscale function and if press **AUTOSET** again, the oscilloscope will enter into Autoscale.
6. Turn off the submenu at the Autoscale menu, the Autoscale is off and turn on the submenu still enters into the function.
7. When video triggering, the horizontal time scale is 50us. If one channel is showing edge signal, the other channel is showing video one, the time scale refers to 50us as video one as standard.
8. While the Autoscale is working, below settings will be made forcibly:

- (1) The unit will switch from non-main time base to main time base status.
- (2) The unit will switch to Peak detection menu while in the state of Average sampling mode.



8.13 Record(only for the HDS2062M-N and HDS3102M-N)

Waveform record: The function provides you to set the time interval between the frames and record the waveform up to 3000 numbers and get the better analysis effect more than before through Playback and Save functions.

Four record modes: Record, Playback, Save, Off.

Record: Record the waveforms up till the set number of frames at specified time intervals.



Record menu list:

Menu	Setting	Instruction
Mode	Record	Select record mode.
	Play back	Select play back mode.
	Storage	Select storage mode.
	Off	Turn off all recorder functions.
End frame	1-3000	Set number of record frames.
Operate	Play	Press to start recording.
	Stop	Press to stop recording.
Interval	1ms~1000s	Set time interval between record frames.
		To next menu
Refreshed	On	The waveforms are in the state of refreshing when recording.
	Off	The waveforms stop refreshing when recording.
Direction	Increase	The value increases from that of end frame to time interval
	Decrease	The value decreases from that of end frame to time interval
		Back to previous menu.

Note: Both the waveforms are recorded at record mode. If one channel is off when recording, the channel data is not available at Playback mode.

Play back: Play back the recorded waveforms.



Play back menu list:

Menu	Setting	Instruction
Play mode	Loop	Set repeat play mode.
	Single	Set single time play mode.
Operate	Play	Press to start playback.
	Stop	Press to stop playing.
Interval	1ms-20s	Set up interval value between frames.
		To next menu
Start frame	1-3000	Set start frame.
Cur frame	1-3000	Select current frame to be played.
End frame	1-3000	Set End frame.
Direction	Increase	The value increases at the mode of setting start frame, cur frame and end frame
	Decrease	The value decreases at the mode of setting start frame, cur frame and end frame
		Back to previous menu.

Note: the Run/Stop button can also replay or continue the waveform display.

Storage: Store recorded waveforms in non-volatile memory according to the setup frames.

Storage menu list:

Menu	Setting	Instruction
Start frame	1-3000	Set first frame to be saved.
End frame	1-3000	Set last frame to be saved.
Direction	Increase	The value increases from the set start frame to the end frame
	Decrease	The value decreases from the set start frame to the end frame
		To next menu
Save		Save recorded waveform to internal memory location.
Load		Recall recorded waveform from internal memory location.
		Back to previous menu.

Record the waveform as follows:

1. Press the **MENU** key and the function menu appears at the right of the screen.
2. Press the **MENU ▲** or **MENU ▼** key to select **Record** and five options are displayed at the bottom of the screen.
3. Press the **F1** key to select the **Record** mode.
4. Press **F2** and set the end frame at 300 (select the direction as Increase or Decrease in the second menu before step4).
5. Press **F4** and set the time interval to 1.00ms.
6. Press **F5** to enter into the second menu.
7. Press **F1** and select **Off** to stop refreshing waveforms.
8. Press **F5** to back up to the first menu.
9. Press **F3** and select **Play** to operate.

Shown as Fig.58 and Fig.59

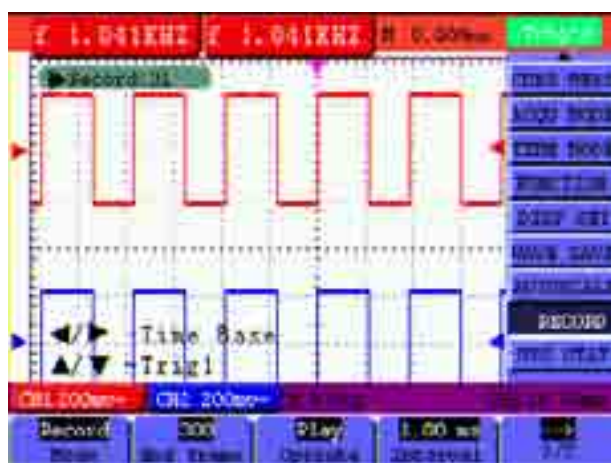

Fig.58: the first page of the record

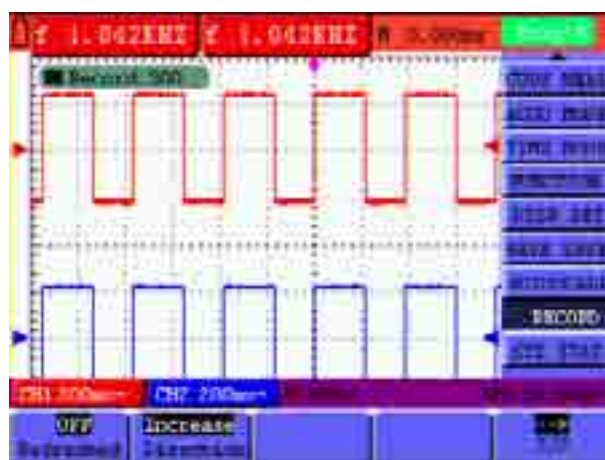

Fig. 59: the second page of the record

8.14 Using FFT

An FFT breaks down signals into component frequencies, which the oscilloscope uses to display a graph of the frequency domain of a signal, as opposed to the oscilloscope's standard time domain graph. You can match these frequencies with known system frequencies, such as system clocks, oscillators, or power supplies.

FFT in this oscilloscope can transform 2048 points of the time-domain signal into its frequency components and the final frequency contains 1024 points ranging from 0Hz to Nyquist frequency .

The following table describes the FFT menu:

Function Menu	Setting	Instruction
FFT	ON	Turn on FFT function
	OFF	Turn off FFT function
Source	CH1	Select CH1 as FFT source
	CH2	Select CH2 as FFT source
Window	Rectangle	Select window for FFT.
	Blackman	
	Hanning	
	Hamming	
Format	dB	Set Vrms as vertical scale unit
	Vrms	Set dBVrms as vertical scale unit
Zoom	*1	Set multiple *1
	*2	Set multiple *2
	*5	Set multiple *5
	*10	Set multiple *10

Taking the FFT operation for example, the operation steps are as follows:

1. Press **MENU** key and the function menu appear on the right side of the screen.
2. Press **MENU ▲** or **MENU ▼** key to select **FFT MODE**. Five items selectable are available at the bottom of the screen.
3. Press **F1** to turn on/off FFT while FFT is not available in Window setting. On/Off shown

means the corresponding function and the green waveform F is shown in the screen after calculation.

4. Press **F2** to switch between channel **CH1** and **CH2** and the current status of channel shows on the top left.
5. Press **F3** to switch over **WINDOW** including **HAMING**、**RECTANGLE**、**Blackman** and **HANNING**.
6. Press **F4** to switch over Format **dB** and **Vrms** .
7. Press **F5** to zoom in or out the waveform, the magnification includes *1, *2, *5, *10 .
8. If the FFT source is CH1, press red button **VOLTS POSITION** ,

- One of the following three prompts circularly will show at the bottom-left of the screen when the format is dB.

▲/▼ — FFT dB level

▲/▼ — CH1 voltage level

▲/▼ — FFT vertical position

- One of the following two prompts circularly will display at the bottom-left of the screen when the format is Vrms.

▲/▼ — CH1 voltage level

▲/▼ — FFT vertical position

Press blue/ button **VOLTS POSITION** and the screen show as follows:

▲/▼ — CH2 OFF

9. If FFT source is CH2, press blue button **VOLTS POSITION** ,

- One of the following three prompts circularly will display at the bottom-left of the screen when the format is dB.

◀/▶ — FFT dB level

▲/▼ — CH2 voltage level

▲/▼ — FFT vertical position

- One of the following two prompts circularly will display at the bottom-left of the screen

when the format is Vrms.

Press red button **VOLTS POSITION** and the screen show as follows:

▲/▼ —CH1 OFF

10. when FFT source is CH1:

- If left bottom of the screen displays "▲/▼-FFT dB level ",press red button **VOLTS POSITION▲** and **VOLTS POSITION▼** menu button to adjust dB value of each DIV, including 1dB 2dB 5dB 10dB 20dB.
- If left bottom of the screen displays "▲/▼-CH1 voltage level " , press red button **VOLTS POSITION▲** and **VOLTS POSITION▼** menu button to adjust voltage of CH1, and "CH1 2v~ "shows in left bottom of the screen;
- If left bottom of the screen displays "▲/▼—FFT vertical position ",press red button **VOLTS POSITION▲** and **VOLTS POSITION▼** menu button to adjust the position of the waveform along the vertical position such as "FFT 1.20 DIV (24.0dB)" which means the pink cursor depatures from the center line for 1.20 DIV and "CH1 20dB" shows on the left bottom, that is the arithmetic product is 24.0dB.

The operation steps are the same as FFT source CH2.

11. Press yellow **OPTION** key, the following prompts shows on the left bottom on the screen.

◀/▶ — CH1 horizontal base

▲/▼ — CH1 trigger level

Or

◀/▶ — CH1 horizontal position

▲/▼ — CH1 trigger level

Please press **OPTION** ◀ and **OPTION** ▶ menu button to adjust the position of the waveform along the horizontal position. "FFT -2.00DIV (500.0Hz) " shown on the left bottom means the section start of the waveform depatures from the Origin for 2.00DIV ,that is 250Hz/DIV.The shown frequency of M is the exact frequency of the cursor point in the middle of spectrum . Shown as Figure.60. Press **OPTION** ◀ and **OPTION** ▶ to adjust horizontal base on horizontal base such as "250Hz/DIV (5KS/s) ".

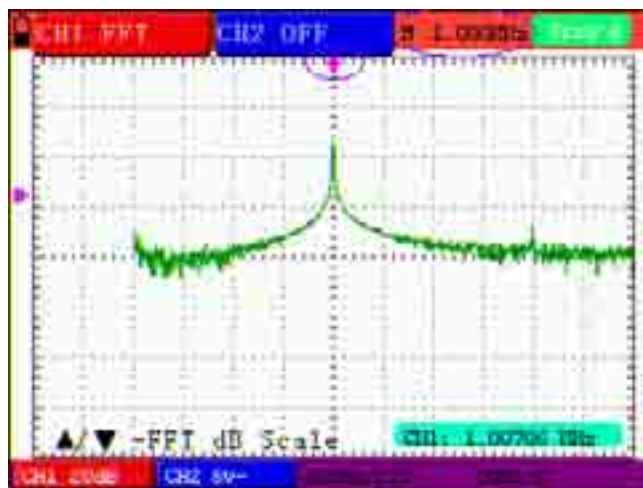

Figure 60

Selecting an FFT Window

■ The FFT feature provides four windows. Each is a trade-off between frequency resolution and magnitude accuracy. What you want to measure and your source signal characteristics help determine which window to use. Use the following guidelines to select the best window.

Type	Description	Window
Rectangle	<p>This is the best type of window for resolving frequencies that are very close to the same value but worst for accurately measuring the amplitude of those frequencies. It is the best type for measuring the frequency spectrum of nonrepetitive signals and measuring frequency components near DC.</p> <p>Use rectangle for measuring transients or bursts where the signal level before and after the event are nearly equal. Also, use this window for equal-amplitude sine waves with frequencies that are very close and for broadband random noise with a relatively slow varying spectrum.</p>	
Hamming	<p>This is a very good window for resolving frequencies that are very close to the same value with somewhat improved amplitude accuracy over the rectangle window. It has a slightly better frequency resolution than the Hanning.</p> <p>Use Hamming for measuring sine, periodic, and narrow band random noise. This window works on transients or bursts where the signal levels before and after the event are significantly different.</p>	



<p>Hanning</p>	<p>This is a very good window for measuring amplitude accuracy but less so for resolving frequencies. Use Hanning for measuring sine, periodic, and narrow band random noise. This window works on transients or bursts where the signal levels before and after the event are significantly different.</p>	
<p>Blackman</p>	<p>This is the best window for measuring the amplitude of frequencies but worst at resolving frequencies. Use Blackman-Harris for measuring predominantly single frequency waveforms to look for higher order harmonics.</p>	

Fig 61,62,63,64 show four kinds of window function referring to sine wave of 1KHz.



Fig 61. Rectangle window



Fig 62. Blackman window

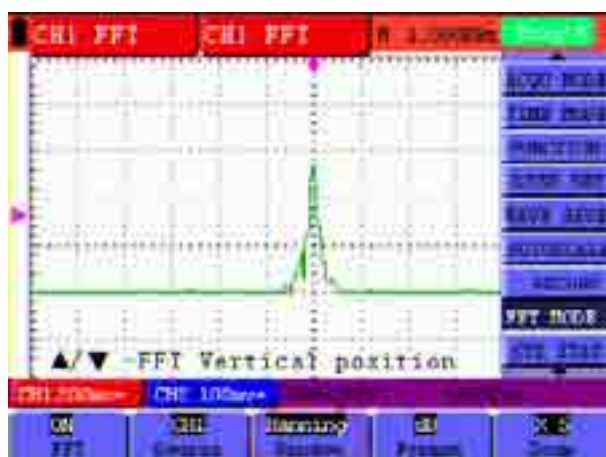

Fig.63 . Hanning window

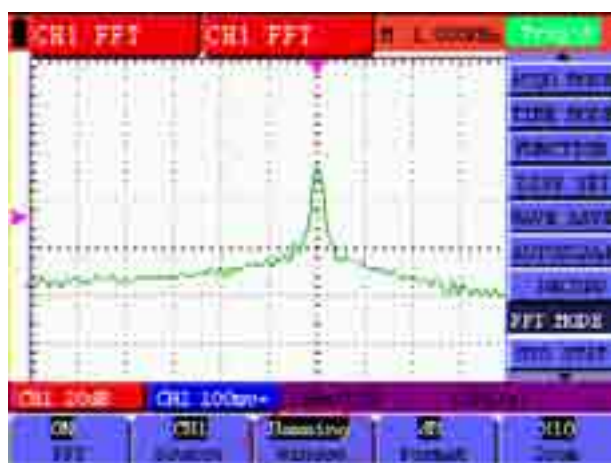

Fig.64. Hamming window

Quick Tips

- If desired, use the zoom feature to magnify the FFT waveform.
- Use the default dBV RMS scale to see a detailed view of multiple frequencies, even if they have very different amplitudes. Use the linear RMS scale to see an overall view of how all frequencies compare to each other.
- Signals that have a DC component or offset can cause incorrect FFT waveform component magnitude values. To minimize the DC component, choose AC Coupling on the source signal.
- To reduce random noise and aliased components in repetitive or single-shot events, set the oscilloscope acquisition mode to average.

Term interpretation

Nyquist frequency: The highest frequency that any Real Time Digital Oscilloscope can measure is exactly half of the sampling rate under the condition of no mistakes, which is called Nyquist

frequency. If under-sampling occurs when the frequency sampled is higher than Nyquist frequency, “False Wave” phenomenon will appear. So pay more attention to the relation between the frequency being sampled and measured.

NOTE:

In FFT mode ,the following settings are prohibited:

- 1) Window set;
- 2) change source channel (in CH1 Setup or CH2 Setup menu);
- 3) XY Format in DISPLAY SET;
- 4) “SET 50%” (the triggering level at the vertical point of signal amplitude) in Trigger setting.;
- 5) Autoscale;
- 6) Wave record;
- 7) Measure 1 and Measure 2.

8.15 System State Menu

The system state menu is used to display information about the present horizontal system, vertical system, trigger system and others. The operation steps are shown as below.

1. Press the **MENU** key and the function menu is displayed at the right of the screen.
2. Press the **MENU ▲** or **MENU ▼** key to select the **System State**. Four options appear at the bottom of the screen.
3. Sequentially press **F1** to **F4** key and the corresponding state information will be shown on the screen.
4. The screen that looks like the following figure 65 will be displayed.



Figure 65: System State

8.15.1 Real time clock

Function: Be synchronous with the U disk storage time.

Do below steps to set up the real time clock:

1. Press **MENU** key and the function menu is displayed on the right side of the screen.
2. Press **MENU ▲** or **MENU ▼** key and select **SYS STAT** and there will be 4 items displayed at the bottom of the screen.
3. Press **F4** key and select **Misc** to display the system time ,see Fig.66.



Fig.66

4. Press **OPTION** to enter into timing mode and if that the background color of the year, month, date, hour, minute, second which are in need of correct be deepened, the value can be adjusted.
5. Press **OPTION ▲** or **OPTION ▼** to change the corresponding value of the year, month, date, hour, minute and second effectively.
6. Press **OPTION ◀** or **OPTION ▶** to switch to the year, month, date, hour, minute and second that are in need of adjustment.
7. Press **OPTION** to enter into normal time mode after timing.
8. If need to timing, please kindly repeat the above steps.

Note: The digital clock stops working when in timing mode.

8.16 Setting of Time Base Mode

The time base mode menu is explained as the following table.

Function menu	Setting	Explanation
Main TimeBase		Horizontal main time base is used to wave display
Zone Window		Use two cursors to define a window area
Window		Expand the defined window to full-screen display

For the operation of window extension, please execute the following steps:

1. Press **MENU** key, display the function menu on the right side of the screen.
2. Press **MENU ▲** or **MENU ▼** key to select time base mode, display three options at the bottom.
3. Press **F2** key to select window setting.
4. Press **OPTION** key, pop up **TIME BASE**, at this time, then press **◀** (yellow) and **▶** (yellow) key to adjust the time base window area defined by two cursors, the window size will vary.
5. Press **OPTION** key and call **TIME**, at this time, press **◀** (yellow) and **▶** (yellow) to adjust the window position defined by two cursors, the window position is the time difference of the window center to main time base's horizontal pointer.
6. Press **F3** key, select window extension, the defined window extends into the full-screen display.

The screen that looks like the following figure 67, 68 will be displayed.

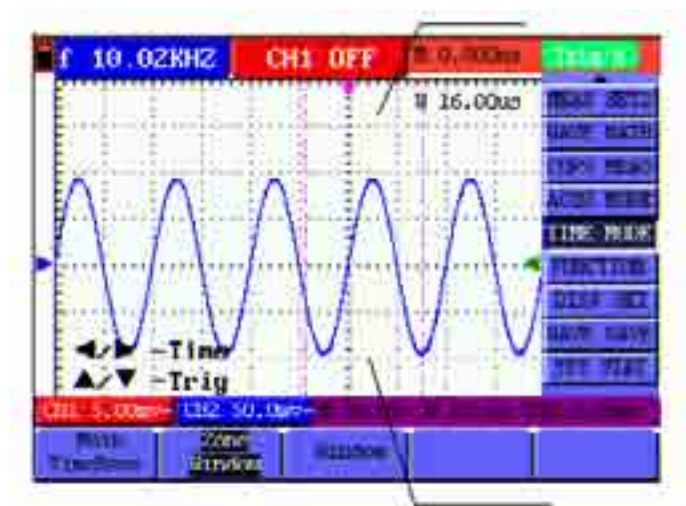

Figure 67: Window Setting

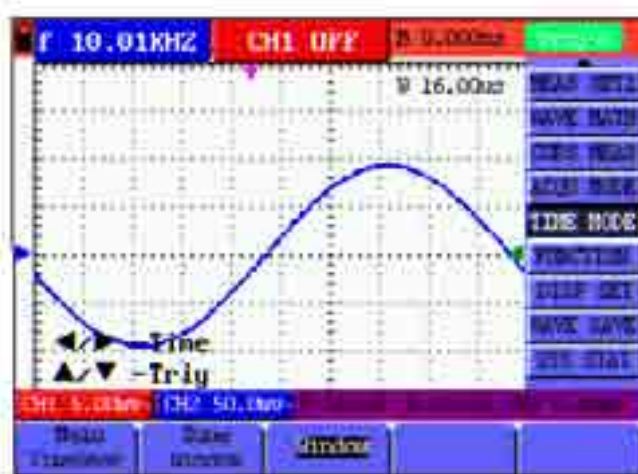

Figure 68: Window Extension

8.17 Data Transmission

For the operation of data transmission, please execute the following steps:

1. Press **MENU** key, display the function menu on the right side of the screen.
2. Press **MENU ▲** or **MENU ▼** key to select display setting mode, display four options at the bottom.
3. Press **F4** key; select the **Bitmap** or **Vectors** for data transmission.
4. Use a data line to connect the oscilloscope and the PC.
5. Open the OWON software that had been installed completely.
6. Setting the parameter under the use's manual, and then starts data transmission.

9. Trouble Shooting

1. The oscilloscope does not power up

It may be caused by the dead battery. At this time, the oscilloscope will not start even if it is powered by the battery charger. Firstly, charge the battery and supply the oscilloscope with power through the battery charger. However, don't switch on the oscilloscope till waiting for 15 minutes. If the oscilloscope still cannot start, please contact OWON for service.

2. The oscilloscope stops working only after operating for several seconds

Probably the battery is dead; Check the battery symbol at the upper left of the screen. The  symbol indicates that the battery has been run out of power and must be charged.

3. The measurement type displays ERR when you switch to the Multimeter mode.

Probably you do not select the measuring mode. In this case, push down any key of the three keys V, A or R. Thus, the relative measuring mode will be shown on the screen. If the ERR is still displayed, restart the oscilloscope.

4. The measured voltage amplitude value is 10 times larger or smaller than the real value under the oscilloscope mode.

Check whether the channel attenuation level matches the actual probe attenuation ratio.

5. The waveform is displayed on the screen but is not stable under the oscilloscope mode.

- Check whether the signal item in the trigger mode menu matches the actually used signal channel.
- Check on the trigger mode: The edge trigger mode is applicable to the universal single and the video trigger mode applicable to the video signal. Only when the proper trigger mode is applied, can the waveform be in stable.
- Try to change the trigger coupling into the HF rejection and LF rejection to filter the HF or LF noise trigger by the interference.

6. There is no display on the screen when you push down RUN/STOP key under the oscilloscope mode.

Check whether the trigger mode in the trigger mode menu is in normal or single shot and whether the trigger level is out of the waveform range.

In such condition, adjust and make the trigger level in the middle or select the non-auto trigger mode. Additionally, press the AUTO SET key and complete the above setting

7. When select the average sampling in the sampling mode or select a longer display time in the display mode under the oscilloscope, the display speed is slow.

It is normal in the above case.

10. Appendix

10.1 Appendix A: Specifications

10.1.1 Oscilloscope

Only if other instructions are provided, are all technical specifications applicable to the probe with the 10X attenuation switch setting and the HDS-N series digital type oscilloscope. In order to be up to these specifications, the oscilloscope should meet the following requirement.

- The instrument should operate continuously for more than 30 minutes under the specified operating temperature.
- If the operating temperature is up to or larger than 5 Celsius degrees, the system function menu must be opened to make the system perform a “Auto- calibration” procedure.

Except those specifications marked with the word **Typical**, all specifications can be up to.

Sampling

Sampling modes	Normal sampling Peak detection Average value
Sampling rate	100 MSa/s----HDS1022M-N 250 MSa/s----HDS2062M-N 500 MSa/s ----HDS3102M-N

Input

Input coupling	DC, AC, Groud
Input impedance	● 1M Ω \pm 2% connected in parallel with 20pF \pm 5pF----HDS1022M-N ● 1M Ω \pm 2% connected in parallel with 15pF \pm 5pF----HDS2062M-N ,HDS3102M-N
Probe attenuation coefficient	1X, 10X, 100X, 1000X
Max. Input voltage	400V (peak)
Channel delay time (typical)	150ps

Horizontal

Sampling rate range	0.25S/s~100MS/s----HDS1022M-N 0.25S/s~250MS/s----HDS2062M-N 0.25S/s~500MS/s----HDS3102M-N
Waveform interpolation	(sin x) /x
Record length	6K points on each channel

Scanning speed range (S/div)	<ul style="list-style-type: none"> ● 5ns/div ~ 100s/div, stepping in the “1-2.5-5” mode---HDS1022M-N ● 5ns/div ~ 100s/div, stepping in the “1-2-5” mode---HDS2062M-N, HDS3102M-N
Sampling rate and delay time accuracy	±100ppm(any time interval which is equal to or larger than 1ms)
Time interval (ΔT)measurement accuracy (full bandwidth)	Single: $\pm (1 \text{ sampling interval time} + 100\text{ppm} \times \text{reading} + 0.6\text{ns})$ $>$ average 16 : $\pm (1 \text{ sampling interval time} + 100\text{ppm} \times \text{reading} + 0.4\text{ns})$

Vertical





Analog digital converter (A/D)	With the resolution of 8 bits, make sampling on both channels synchronously.
Sensitivity range (V/div)	5mV/div~5V/div (at the input BNC)
Displacement range	<ul style="list-style-type: none"> ● $\pm 10\text{div}$---HDS1022M-N ● $\pm 2\text{V}(5\text{mV/div} \sim 200\text{mV/div), \pm 50\text{V}(500\text{mV/div} \sim 5\text{V/div)}$ ---HDS2062M-N ● $\pm 1\text{V}(5\text{mV/div} \sim 100\text{mV/div), \pm 10\text{V}(200\text{mV/div} \sim 1\text{V/div) \pm 50\text{V}(2\text{V/div} \sim 5\text{V/div)}$ ---HDS3102M-N
Analog bandwidth	20MHz---HDS1022M-N 60MHz---HDS2062M-N 100MHz---HDS3102M-N
Single bandwidth	Full bandwidth
Low frequency response (AD coupling, -3dB)	$\geq 5\text{Hz}$ (at the BNC)
Rise time (typical one at the BNC)	$\leq 17.5\text{ns}$ ---HDS1022M-N $\leq 5.8\text{ns}$ ---HDS2062M-N $\leq 3.5\text{ns}$ ---HDS3102M-N
DC gain accuracy	±3%
DC measurement accuracy (average value sampling mode)	The voltage difference (ΔV) between any two points on the waveform after averaging the captured waveforms more than 16: $\pm (5\% \text{ reading} + 0.05 \text{ divisions})$.

Trigger

Trigger sensitivity (Edge triggering)	DC coupling	1div(DC~full bandwidth)
	AC coupling	Same as the DC coupling when it is equal to or larger than 50Hz.
Triggering level range	±6 divisions from the screen center	

Triggering level accuracy (typical) which is applicable to the signal with rise and fall time equal to or longer than 20ns	± 0.3 divisions
Trigger displacement	655 divisions for pre-triggering and 4 divisions for post-triggering.
Trigger Holdoff range	100ns~10s
Make a 50% level setting (Typical).	Operation with the input signal frequency equal to or larger than 50Hz.
Trigger sensitivity (Video triggering and typical mode)	2 divisions of peak-to-peak value
Signal system and line/field frequency (Video triggering mode)	Support the NTSC, PAL and SECAM broadcasting systems of any field or line frequency.
Cymometer (only for HDS2062M-N and HDS3102M-N)	
Readout resolution	6 digits
Frequency range	AC coupling, 2Hz to full bandwidth
Single source	<ul style="list-style-type: none"> ● when the triggering mode is edge triggering, it is a one channel Cymometer. ● When the triggering mode is alternating triggering, it is a two channel cymometer. ● When the triggering mode is video triggering, the cymometer will not work..

Measurement

Cursor measurement	Voltage difference (ΔV) and time difference (ΔT) between cursors
Auto measurement	Peak-to-peak value, average value, root mean square value, frequency, period, Vmax, Vmin, Vtop, Vbase, Vamp, Overshoot, Preshoot, RiseTime, Fall Time, +Width, -Width, +Duty, -Duty, DelayA  B  and DelayA  B  .

Probe

	1X position	10X position
Bandwidth	Up to 6 MHz (DC)	Up to full bandwidth (DC)
Attenuation rate	1: 1	10: 1
Compensation range	15pf~35pf	
Input resistance	1M Ω $\pm 2\%$	10M Ω $\pm 2\%$
Input impedance	85pf~115pf	14.5pf~17.5pf
Input voltage	<200 V DC+Peak AC	<600 V DC+Peak AC

10.1.2 Meter

Voltage (VDC)

Input Impedance: 10M Ω .

Max. Input Voltage: 1000V (DC or AC peak-to-peak value)

Range	Accuracy	Resolution
400.0mv	$\pm 1\% \pm 2$ digit	100uV
4.000V		1mV
40.00V		10mV
400.0V		100mV
1000.0V		1V

Voltage (VAC)

Input Impedance: 10M Ω .

Max. Input Voltage: 750V (AC, virtual value)

Frequency range: from 40Hz to 400Hz.

Display: Virtual value of the sine wave

Range	Accuracy	Resolution
4.000V	$\pm 1\% \pm 3$ digits	1mV
40.00V		10mV
400.0V		100mV
750.0V	$\pm 1.5\% \pm 3$ digit	1V

Direct Current (DC)

Range	Accuracy	Resolution
40.00mA	$\pm 1.5\% \pm 1$ digit	10uA
400.0mA	$\pm 1.5\% \pm 1$ digit	100uA
10A	$\pm 3\% \pm 3$ digit	10mA

Alternating Current (AC)

Range	Accuracy	Resolution
40.00mA	$\pm 1.5\% \pm 3$ digit	10uA
400.0mA	$\pm 2\% \pm 1$ digit	100uA
10A	$\pm 5\% \pm 3$ digit	10mA

Resistance

Range	Accuracy	Resolution
400.0 Ω	$\pm 1\% \pm 3$ digit	0.1 Ω
4.000K Ω	$\pm 1\% \pm 1$ digit	1 Ω
40.00K Ω		10 Ω
400.0K Ω		100 Ω
4.000M Ω		1K Ω

40.00M Ω	$\pm 1.5\% \pm 3$ digit	10K Ω
-----------------	-------------------------	--------------

Capacitance

Range	Accuracy	Resolution
51.20nF	$\pm 3\% \pm 3$ digit	10pF
512.0nF		100pF
5.120uF		1nF
51.20uF		10nF
100uF		100nF

Diode

Voltage reading: 0 V \sim 1.5 V.

On-off Test

There is a beep sound when the on-resistance is less than 50 Ω .

10.1.3 General Specifications**Basic parameter**

Mechanical dimension	18 cm \times 11.5cm \times 4cm
Weight	645 g
Power consumption	< 6 W----HDS1022M-N, HDS3102M-N < 7 W----HDS2062M-N
Display type	3.7" color liquid crystal display
Display resolution	640 (horizontal) \times 480 (vertical) pixels
Display color	65536 colors

Power Adapter

Power supply	100-240 V AC 50/60Hz
Power output	1.5VDC----HDS1022M-N 9 VDC----HDS2062M-N, HDS3102M-N
Current output	1500mA----HDS1022M-N 3000mA----HDS2062M-N, HDS3102M-N

Battery type: 7.4V built-in Li-ion battery.

Working environment

Temperature

Operation

Used battery 0 to 50 $^{\circ}$ C (32 to 122 $^{\circ}$ F)

Power adapter 0 to 40 $^{\circ}$ C (32 to 104 $^{\circ}$ F)

Storage -20 to +60 $^{\circ}$ C (-4 to 140 $^{\circ}$ F)

Temperature

Operation:

0 to 10 °C (32 to 50 °F) no condensation

10 to 30 °C (50 to 86 °F) 95 %

30 to 40 °C (86 to 104 °F) 75 %

40 to 50 °C (104 to 122 °F) 45 %

storage

-20 to +60 °C (-4 to +140 °F). no condensation

10.2 Appendix B: Maintenance and Cleaning

10.2.1 Maintenance

Do not store or place the instrument in locations where the liquid crystal display (LCD) may be directly exposed to the sunshine for a long time.

Be careful: Do not spray liquid into the instrument.

Cleaning

Inspect the instrument and the probe frequently in accordance with operating conditions. Clean the outer surface of the instrument according to the following steps:

1. Wipe off the floating dust outside of the instrument and the probe by using soft cloth. When cleaning the LCD, do not scuff the transparent LCD protective screen.
2. Wipe the instrument in power off status by soft cloth that is moist but not dripping. It is allowed to be cleaned by soft detergent or fresh water. Do not use any abrasive chemical detergent to avoid the instrument or the probe being damaged.



Warning: Before running, please confirm that the instrument has been dried out so as to avoid electrical short circuit and personal injury caused by moisture.



10.2.2 Storage of Oscilloscope

If the test tool is to be stored for a long time, it is required to charge the lithium battery before storage.

Charging the oscilloscope

The lithium battery is possibly not charged when delivery. To make the battery with enough electric quantity, it must be charged for 4 hours (the test tool must be turned off during charging).

The battery can supply power for 4 hours after being charged completely.

When supplying power by using the battery, a battery indicator is displayed on the top of the screen to show the consumption condition of electric quantity. The symbols that are possibly appear include , where  shows that the battery can only be used for about 5 minutes. To charge the battery and power the instrument, connect the oscilloscope using a power adapter according to Figure 1 to charge the battery. The charging speed can be increased by turning off the test tool.

Notice

To avoid superheat of battery during charging, the environment temperature is not allowed to exceed the permissible value given in technical specification.

Note:

No hazard will occur even connecting the charger for a long time, e.g. during a whole weekend. The instrument can automatically switch to slowly charging status.

10.2.3 Replacing the Lithium Battery Unit

It is usually not required to replace the battery unit. But when it is required to replace it, only

qualified personnel can carry out this operation, and only use the same specification lithium battery.