

Modline[®] 5 Infrared Thermometers



Noncontact stand alone temperature sensors
to serve a wide range of applications





Superior temperature accuracy and smart features to serve a wide range of applications

52 Series	5R Series	5G Series	56 Series
500 to 3000°C (932 to 5432°F) 0.85–1.1µm High-temperature sensors ideal for processes such as metal forging, annealing, hardening, and foundries.	600 to 3000°C (1112 to 5432°F) 0.75–1.05µm and 1.0–1.1µm (2-color) Dual-detector high-temperature sensors for difficult processes such as vacuum furnaces, kilns, molten metals, and thin wires or rods.	250 to 2000°C (482 to 3632°F) 1.6µm 1.6 micron mid-temperature sensors ideal for ferrous/non-ferrous metal treating applications.	50 to 800°C (122 to 1472°F) 2µm 2 micron sensors ideal for spot welding, or induction heating as well as low-temperature rubber, thick plastic or small wire coating applications.

Modline 5

If reliable, accurate temperature measurement and easy operation are critical to your process, look to the features of the Modline 5 series.

Outstanding Performance

Like the long line of superior, industrial-strength IRCON infrared thermometers before it, Modline 5 is a top performer. Designed to serve a variety of applications and withstand hostile environments with accuracy and repeatability, you can rely on Modline 5 with your process.

Intelligent, Assured Accuracy

With Modline 5, temperature should no longer be in question when monitoring your process. Modline 5 thermometers include System Health Check, calibration check and other smart features that help verify optimal operation. It will automatically detect that it is performing correctly, or let you know where it is not. Even the lens window can automatically monitor itself to assure it is clear of debris!

Small, Durable and Capable

Designed to withstand long terms in harsh environments, all components of the sensor are contained within a sealed, stainless steel NEMA 4 (IP65) enclosure. With a diameter less than 5.7cm (2.25 inches), it is one of the most capable small infrared thermometers on the market.

Flexible Control Possibilities

With abilities to function both stand alone and networked, standard I/O signal interfaces (both analog and bi-directional RS-485 digital) enable operation with other systems and devices. Achieve insight, quality and efficiency like never before with Modline 5 sensors integrated with your process.

Simple Installation and Operation

It all adds up to low overall costs. Beyond being a top performer in terms of reliable accuracy and flexible control possibilities, count on Modline 5 being easy to operate:

- Precise focus takes only a twist
- Free software simplifies configuration and lets you monitor sensor operation remotely
- Match Function takes the guess work out of setting emissivity
- Sensor Health Check and Dirty Window Detector operation automatically monitors sensor conditions so that you will not have to
- Accessories are designed to allow configuration and focus without having to physically remove the sensor

56 Series Highlights

- 2 Micron Unit
- Lower Temperature Range (down to 50°C)
- Thermo-Electrically Cooled Detector
- Internal Self-Calibration Feature

Precise focus, rear-adjustable optics

Focus precisely on target using a small spot size by twisting the back portion of the sensor housing

Automatic sensor health check

Built-in 'smart' electronics assure accuracy

Emissivity match function

If you already know the temperature, the sensor can determine the emissivity

Two-color dual detector models available

For handling tough temperature measurement jobs

Dirty window detector (DWD) option

Assure accuracy and reduce maintenance time

Smart line of accessories

Simplify operation and assure a long sensor life

Durable, sealed, stainless steel enclosure

NEMA 4 (IP65) rated enclosure fully protects electronic components—even the display and keypad

Built-in, thru-the-lens visual or laser sighting

See exactly what the sensor measures

Flexible control options

Integrate Modline 5 sensors with your process

Free PC software for remote setup, configuration and monitoring provided with each sensor

Sensor Features

The Modline 5 series offers a small sensor with big capabilities:

Intelligent Design

- High resolution Modline 5 optics and adjustable focus enable precise targeting. Distance objects can be measured using a very small focal area or “spot size”.
- Target sighting is precise and easy—Two built-in, thru-the-lens options are available: Visual or Laser. Adjust focus by turning the rear portion of the sensor, which can be locked into position.
- A line of flexible accessories simplify Modline 5 installation and operation and replacement of older equipment. All sensor settings and focus can be adjusted even with all Modline 5 accessories installed (see page 6 for more details).



Assured Accuracy

A System Health Check feature offers tools that help start-up troubleshooting, instrument maintenance and assuring accuracy.

System Health Check refers to self-diagnostic capabilities (including calibration check) that are built into all Modline 5 sensors. When activated, the sensor electronics are verified to instruments specifications set at the factory. If any issues are detected, the sensor will issue an alarm (on the sensor display and through output signals) with information regarding the nature of the error.

System Health Check can be programmed to automatically check the system at regular intervals, and can be initiated from remote sources connected through the sensor cable.

With 56 Series, internal self-calibration can also occur automatically, if necessary.

Combine System Health Check with the Dirty Window Detector (DWD) option and other Modline 5 accessories to assure greatest temperature accuracy.

Unique Emissivity Match Function

What can be a complex and frustrating process—determining emissivity to achieve correct temperature readings—is simplified with the Modline 5 Match Function. Simply aim the sensor at the target and adjust settings to the known temperature—Emissivity settings will be automatically adjusted.



The Laser Sighting option makes it easy to focus the sensor and attain ideal spot size on targets that are difficult to see. Simply aim and rotate the rear section of the sensor to achieve desired focus.

Sensor Options

Beyond having a selection of lenses and temperature and spectral ranges to choose from, each Modline 5 sensor can be ordered with the following helpful options:

Dirty Window Detector (DWD)

All infrared sensors will experience some loss of measurement accuracy if the window becomes obscured due to dust, condensation, or other contaminants.

The Modline 5 offers an innovative Dirty Window Detector (DWD) option to address this matter. The DWD automatically detects if build-up on the window is present and sends an alarm output to notify you.



The Dirty Window Detector option protects the sensor lens, and automatically monitors and informs you if debris has built up on its window. Many customers find this option to be a great maintenance saver. (Patent #5812270)

Even in relatively clean environments where fluctuations in signal accuracy can have an extreme effect on a reading, the DWD provides added insurance that the temperature measurement is accurate.

A traditional solution for preventing build-up is to install an air purge accessory, designed to continuously blow compressed air across the sensor lens or window. While this solution typically works well, there are cases where it is not always practical, such as when sensor mounting space is limited or when an air source is unreliable or expensive to install.

If you require multiple levels of assurance, the small Modline 5 APA air purge is designed to function with the Modline 5 sensor with the DWD option installed.

Thru-the-lens Laser Sighting

With the built-in Laser Sighting option, the size of the laser spot represents the detection area or “spot” size.

It is a helpful tool for verifying the precise focal area where temperature will be measured and for focusing on targets that are difficult to see.

The laser is turned on and off by pressing a button on the rear display. If the sensor is mounted in a difficult-to-reach location, the laser can also be triggered on and off by remote switch or other devices connected through the sensor cable.

Calibration Transfer Standard

The convenience of on-site sensor calibration testing is possible with the Transfer Standard option. Supplied with calibration software and NIST-traceable calibration results, a Transfer Standard Modline 5 sensor can be a tool against which all your other Modline 5 sensors are measured (see page 5 for detail).

Sensor Setup and Configuration Options

The Modline 5 series offers you numerous configuration and interface options, enabling you to flexibly adapt your temperature monitoring strategy with your requirements. Whether you need simple temperature display or demand complex systems interoperability, Modline 5 solutions can help you reach your goals.

Rear Display Controls

All settings can be controlled through the keypad on the back of the sensor. The bright alphanumeric LED display provides menu prompts; temperature display in °C or °F; and alarm prompts if critical conditions exist. The display can be viewed clearly through a protective window that comes standard with the unit.

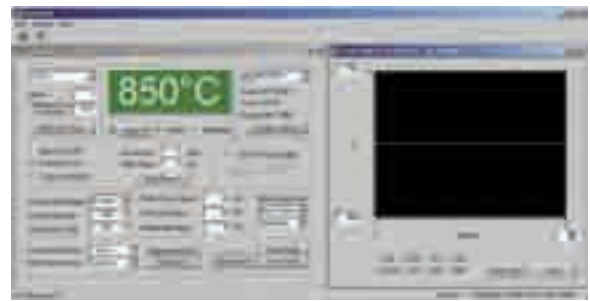

Modview Configuration Software

Modview Configuration Software is a PC-based setup and monitoring tool supplied with every Modline 5 sensor. It enables communication between the PC and a sensor through bi-directional RS-485 digital communications:

- All sensor parameters can be viewed and adjusted through a PC, using a single window “dashboard”
- Settings files can be saved and re-used for configuring other Modline 5 sensors
- A trend screen provides real-time, graphical display of temperature readings
- Temperature data can be recorded over time and exported as a CSV file for archiving, trending and reporting purposes

Multi-Sensor Interface (MSI)

Centrally and simultaneously monitor multiple temperature points and alarms, and remotely configure and adjust settings for up to twelve Modline 5 sensors—on the production floor, over your company network or the Internet.

The MSI incorporates a 10 inch NEMA 4 (IP65) display with touch keys, processing capabilities and multiple communication ports, enabling greater process monitoring and control flexibility.



The system comes pre-programmed to function with Modline 5 sensors, can capture and save trend data, and can communicate with process control, PLC, and SCADA system using RS-232, 485, or ethernet.

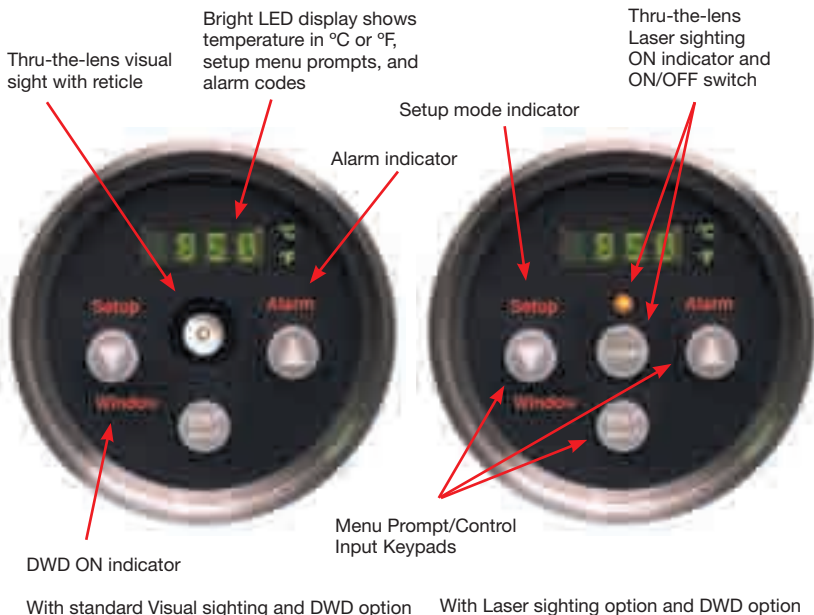

Digital Panel Meter (DPM)

The DPM makes it simple to remotely control and monitor Modline 5 sensors mounted in hard-to-reach or hazardous locations. More than just a temperature display—it is a complete Modline 5 sensor configuration and monitoring tool, including System Health Check capabilities.

Menu commands entered through the DPM, connected via RS-485 serial communication. All Modline 5 menus are pre-loaded on the DPM so that it is ready to communicate with a sensor after wiring.



An optional relay board can be ordered to provide four user-configurable temperature alarms. The DPM is powered separately from the Modline 5 and requires 85 to 250 VAC 50/60 Hz power.

Modline 5 System Configuration Possibilities:

ModView Configuration Software

(On PC on production floor or at remote location)



- Configure sensor remotely
- Display temperature
- Display temperature trend data
- Monitor Sensor Health Check status
- Archive trend data as CSV files

Digital Panel Meter (DPM)

(Panel mounted on production floor)



- Configure sensor remotely
- Display temperature
- Display temperature alarms

Multi-Sensor Interface (MSI)

(Panel mounted on production floor)

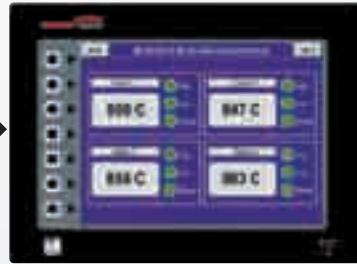

- Configure sensors remotely
- Display temperatures
- Display temperature alarms
- Display temperature trend data
- Monitor Sensor Health Check status
- Archive trend data as CSV files
- Display temperatures / change sensor settings via Network or Internet using Built-In Web Server

PLCs
PCS / Scada
Internet
Company Network
Other PCs
Printer

... and other systems where external control is required

Configure and monitor up to twelve Modline 5 sensors simultaneously

Sensor Power and Interface Options

There are three options to power and connecting a Modline 5 sensor:

Modline 5 POI (Power/Output/Input) Box

The Modline 5 POI Box combines a Terminal Strip Plate and Switching Power Supply (described below) within a NEMA 4 (IP65) rated enclosure with conduit connection ports. It enables easy wiring of the Modline 5 sensor cable, overall system CE certification compliance, and connectivity with external systems. Modline 5 sensor with the DWD option installed.



Modline 5 Terminal Strip Plate (TSP) and Switching Power Supply

If you want to use your own enclosure and continue to assure CE compliance of your Modline 5 system, a Switching Power Supply and Terminal Strip Plate (similar to that supplied with the POI Box above) may be purchased separately. The power supply provides 24 VDC/635 mA output and requires 100 to 240 VAC 50/60 Hz input.

The Terminal Strip Plate enables easy wiring of the sensor cable, connectivity with external systems and is required to maintain Modline 5 system CE compliance.



Modline 5 Terminal Strip Plate (TSP)

If you would prefer to use your own enclosure and power supply, the Modline 5 Terminal Strip Plate is sold independently.



Sensor Calibration Testing

Modline 5 Transfer Standard Sensors with ModView Calibration Software enable the convenience of on-site calibration

For operations that require frequent sensor calibration testing due to regulatory or process requirements, IRCON offers Modline 5 Transfer Standard units.



Modline 5 Transfer Standard sensors are validated to extremely high precision (traceable to NIST) at our factory, and supplied with a detailed calibration certificate.

Using a Modline 5 Transfer Standard sensor with ModView Calibration Software (included with each Transfer Standard unit purchase) and a blackbody source, you can test and calibrate other Modline 5 sensors on-site to assure the same levels of accuracy. ModView Calibration Software may be purchased independently.

IRCON also offers a range of blackbody source products and sensor calibration testing services conducted at your location or with the sensor(s) shipped to an IRCON service center near you.

Sensor Specifications

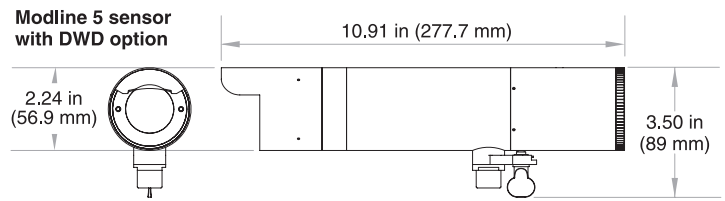
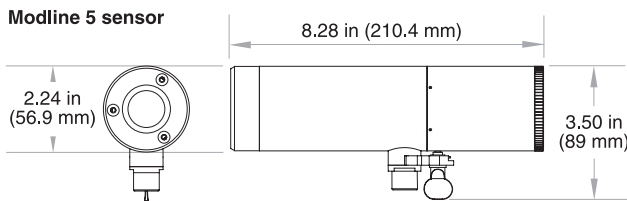

	52 Series	5R Series (Ratio)	5G Series	56 Series
Performance				
Spectral Range	0.85–1.1µm	0.75–1.05µm; 1.0–1.1µm (ratio mode) 1.0–1.1µm (single color)	1.6µm	2.0–2.8µm (56-0315 only) 2.3–2.6µm (56-0515, 56-0815)
Accuracy @ 25°C	0.3% of reading, +1°C	0.5% of reading, plus 2°C	0.3% of reading, +1°C	0.3% of reading +1°C, or 2°C (whichever is greater)
Response Time	6.6ms	10ms	6.6ms	20ms
Emissivity	0.100–1.000	0.100–1.000 (single color mode)	0.100–1.000*	0.100–1.000*
E-slope Range	N/A	0.800–1.200 (ratio mode)	N/A	N/A
Repeatability	@25°C 0.1% of full scale, plus 1 digit (all models)			
Signal Processing	Peak Picker and Track & Hold (all models)			
Sighting	Internal, thru-the-lens Visual (standard) or Laser (optional)			

* Emissivity span is limited to 0.3–1.0 for the first 55°C (100°F) for all temperature ranges

Inputs/Outputs

- Analog Output (scalable) 0–20mA, 4–20mA with 600 ohm Max. load
- Analog Input 4–20mA (emissivity or e-slope or Laser)
- Relay Output System Alarm (24 VAC/DC @ 1amp resistive)
- Digital Input/Output RS-485 (user selectable, 57.6K max)
- Power Requirements 24 VDC +/-5%, 8 Watts Max.

Physical/Environmental

- Environmental Rating NEMA 4 (IP65)
- Weight (sensor only) 1.4kg (3.1 lbs)
- Humidity 10 to 90% non-condensing
- Shock IEC 68-2-27
- Vibration IEC 68-2-6

Operating Ambient Temperature

- Without Cooling 0 to 55°C (32 to 130°F)
- With Air Cooling 0 to 105°C (32 to 220°F)
- With Water Cooling 0 to 200°C (32 to 400°F)
- Storage Temperature 20 to 70°C (-4 to 60°F)
- Cable Temperature 200°C Max. (392°F Max.)



Product Compliance

- The Modline 5 POI box and TSP Plate meet the following standards:
- EN61010-1:2001, Safety Requirements
- EN 55011:1998, Amend. A1:1999 Emissions for Industrial Equip.
- EN 61326-1:1997 Immunity Test Req. for Industrial Locations
- UL 61010B-1, 2003, General Requirements
- CSA C22.2 No. 1010.1, 1997, General Requirements

Accessories

IRCON Modline 5 sensor hardware accessories are designed to simplify installation and maintenance, enable greater operator safety, and assure sensor accuracy and protection while operating in harsh environments.

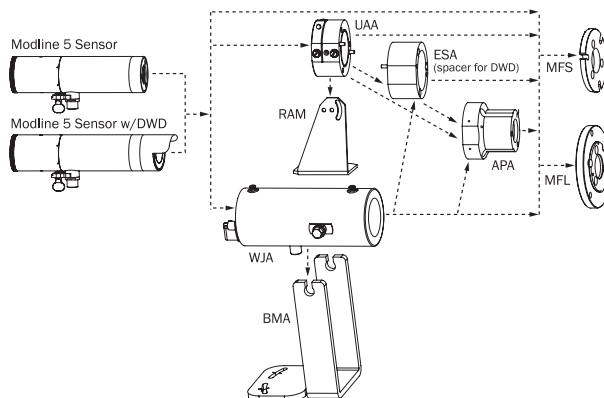

WJA (Water Jacket Accessory) and BMA (Base Mount Adapter)



The Water Jacket Accessory (WJA) protects a Modline 5 sensor from extreme ambient temperatures.

Circulating water or air through the jacket lining helps to maintain a constant and cool sensor operating temperature, assuring greater accuracy and long term reliability.

The adjusting Base Mounting Adapter (BMA) can be used for mounting the WJA. If flange mounting is preferred, the Mounting Flange–Large (MFL) or Mounting Flange–Small (MFS) can also be used.

Sensor Selection and Ordering

The Modline 5 sensor model number, lens, cable length and any factory installed options you prefer must be specified at the time you place the order.

Sensor and Lens Ordering Numbers

	Temperature Range	Spectral Range	Lens and Optical Resolution			Primary Applications
			(One lens per sensor. See Diagram below)			
			2A	2B	2C	
52-1410	500 to 1400°C (932 to 2552°F)	0.85–1.1µm	D/100	D/90	D/80	High Temperature Processes
52-2020	600 to 2000°C (1112 to 3632°F)	0.85–1.1µm	D/200	D/180	D/160	Metal forging, annealing, hardening
52-3024	750 to 3000°C (1382 to 5432°F)	0.85–1.1µm	D/240	D/216	D/192	foundries, and incandescent processes
			RA	RB	RC	
5R-1410	600 to 1400°C (1112 to 3632°F)	0.75–1.05µm; 1.0–1.1µm	D/100	D/90	D/80	Difficult High Temperature Processes
5R-1810	700 to 1800°C (1292 to 3272°F)	0.75–1.05µm; 1.0–1.1µm	D/100	D/90	D/80	Molten Metals, small wires, small
5R-3015	1000 to 3000°C (1832 to 5432°F)	0.75–1.05µm; 1.0–1.1µm	D/150	D/135	D/120	rods, vacuum furnaces and kilns
			2A	2B	2C	
5G-1007	250 to 1000°C (482 to 1832°F)	1.6µm	D/75	D/67	D/60	Mid to High Temperature Processes
5G-1415	300 to 1400°C (572 to 2552°F)	1.6µm	D/150	D/135	D/120	Ferrous and non-ferrous metal treating
5G-2024	350 to 2000°C (662 to 3632°F)	1.6µm	D/240	D/216	D/192	
			6A	6B	6C	
56-0315	50 to 300°C (122 to 572°F)	2.0–2.8µm	D/150	D/135	D/105	Mid and Low Temperature Processes
56-0415	100 to 400°C (212 to 752°F)	2.3–2.6µm	D/150	D/135	D/105	Spot welding, induction heating
56-0815	200 to 800°C (392 to 1472°F)	2.3–2.6µm	D/150	D/135	D/105	thick plastic, rubber & textiles, wire coating

Factory-Installed Sensor Options

Each item below must be specified with each sensor ordered.

- Cable Length** The length of the interconnecting cable between a Modline 5 sensor connector port and POI Box/Terminal Strip Plate may be tailored to your requirements up to a maximum of 107 meters (350 feet).
- Laser Sighting** The built-in thru-the-lens Laser sight option must be specified at the time of order—unless specified, Visual sight will be installed.
- Dirty Window Detector** The DWD option (supplied with ESA accessory) requires factory installation—unless specified, a sensor without DWD will be shipped.
- Transfer Standard** Calibration Transfer Standard model sensors, supplied with ModView Calibration Software will be shipped with this option selected. ModView Calibration Software may be ordered independently without a Transfer Standard sensor. See pages 3 and 5 for more detail.

Formula to determine measurement area spot size:

$$d = D/F$$

- d** = Diameter of desired spot size at focal point
- D** = Distance from front of sensor to focal point (w/DWD, add 66mm or 2.6 inches from hood tip)
- F** = Optical Resolution factor of sensor model and lens combination

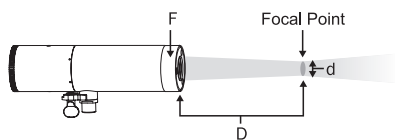

Lens	Focusing Range
2A	330mm to infinity (13 inches to infinity)
2B	152 to 305mm (6 to 12 inches)
2C	57 to 70mm (2.25 to 2.75 inches)
RA	330mm to infinity (13 inches to infinity)
RB	178 to 355mm (7 to 14 inches)
RC	57 to 70mm (2.25 to 2.75 inches)
6A	305mm to infinity (12 inches to infinity)
6B	152 to 305mm (6 to 12 inches)
6C	44 to 57mm (1.75 to 2.25 inches)



RAM (Right Angle Mount)

The RAM bracket offers a convenient way to mount a Modline 5 sensor to a surface. The UAA (described below) is required to attach the sensor to the RAM.



MFL (Mounting Flange—Large)

The MFL can be mated to a Modline 5 sensor by bolting it to the Universal Adapter Assembly (UAA), Air Purge (APA), or Water Jacket (WJA) accessory. It has a bolt pattern that also matches other IRCON products.



UAA (Universal Adapter Accessory)

The UAA clamps around a Modline 5 sensor, and can be used to mount it to a RAM bracket (described above), a tripod, or any device using a 1/4–20 UNC threaded mounting hardware.



MFS (Mounting Flange—Small)

The smaller MFS mounting flange is available, designed with a bolt pattern to match many infrared thermometers on the market. Like the MFL, the MFS can be mated to a Modline 5 sensor by bolting it to the Air Purge Accessory (described below).



ESA (Extension Sleeve Adapter)

The ESA serves as a spacer, and is required for many accessories (APA, MFL, MFS) used with Modline 5 Dirty Window Detector (DWD) equipped sensors. The ESA is supplied with the purchase of Modline 5 sensors equipped with the DWD option.



APA (Air Purge accessory)

This specially designed air purge is used to help keep Modline 5 sensor optics clean. This unit mounts to the front of the sensor and requires the UAA or WJA to mount it in place.

Experience the difference

Count on IRCON to help you find solutions to your temperature monitoring challenges. IRCON offers on-site equipment demonstrations, consulting, training and other arrangements to help you experience our products and prove their ability to meet your needs.

About IRCON

If you are looking for solutions to difficult temperature measurement and monitoring challenges, IRCON is the company to call. IRCON offers a product range and experience that are unmatched in the industry.

In business since 1962, IRCON products perform with accuracy and repeatability in the harshest and most volatile conditions that require precise temperature measurement and control.

Our solutions are designed to suit a wide variety of applications, with a product line capable of measuring temperatures from 50 to 6500°C (-50 to 3500°F).

Whether you do research or are in the business of manufacturing or processing metals, glass, plastics, ceramics, paper, textiles, chemicals, packaging, food or pharmaceutical, chances are IRCON has a solution to address your situation.

Global service and support solutions

Beyond leading-edge products and expertise, you can count on IRCON for a variety of valuable services and support options, including:

- Product warranty programs
- Fixed repair cost programs
- On-site repair and preventative maintenance
- On-site technical consulting and troubleshooting
- Operator training
- Sensor re-calibration and certification service

Through our network of nearly 150 distributors around the globe, and service centers in North America, Europe, and Asia—no matter where you are, IRCON specialists are near you to assist.

For additional information, please visit our website contact an IRCON specialist in your area, or submit a request at www.ircon.com/tech_request

To find the IRCON office or products representative nearest you, please visit www.ircon.com/reps

The Worldwide Leader in Noncontact Temperature Measurement

IRCON, Inc.

Worldwide Headquarters

Santa Cruz, CA USA

Tel: 1 800 227 8074 (USA and Canada, only)

1 831 458 3900

info@ircon.com

European Headquarters

Berlin, Germany

Tel: 49 30 4 78 00 80

France

Tel: 0800 888 244

United Kingdom

Tel: +44 1908 630 800

China Headquarters

Beijing, China

Tel: 8610 6438 4691

To find an IRCON office near you, please visit www.ircon.com

Worldwide Service

IRCON offers services, including repair and calibration.

For more information, contact your local office or e-mail info@ircon.com

www.ircon.com



Raytek is an ISO 9001 certified company



© 2008 IRCON, Inc. (3312168 Rev F) 2/2008
The IRCON logo is a registered trademark of IRCON, Inc.
Specifications subject to change without notice.